

# 2019 National Silver Gloves

Final Bout # 101

## Boys 8 Open 8 - 8 50 Lbs

**!!! CAUTION !!! ==> SUBJECT TO CHANGE !!!**

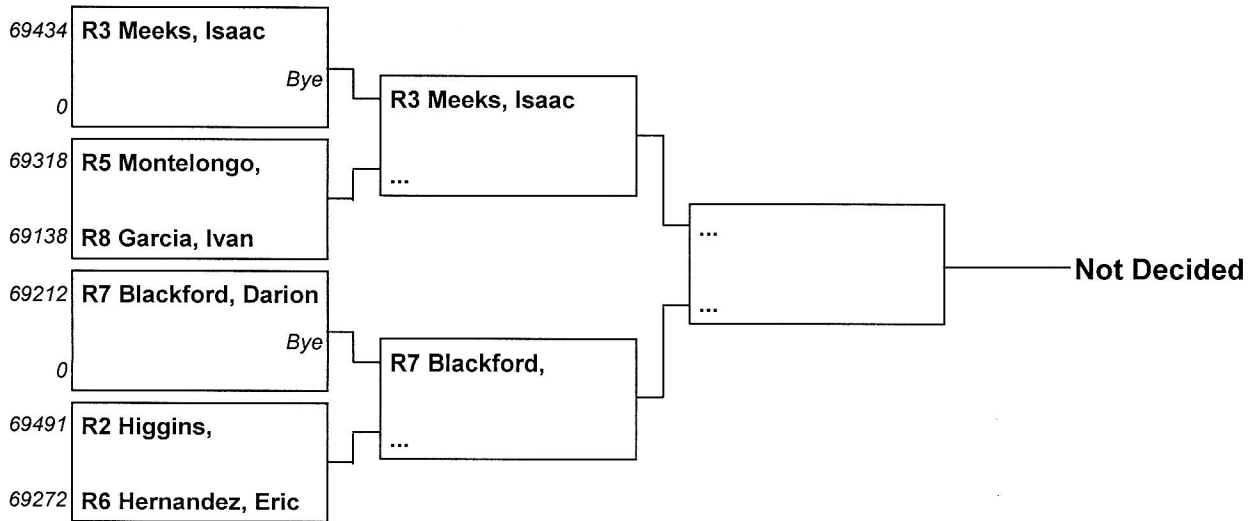

## Girls 8 Open 8 - 8

### 55 Lbs

**!!! CAUTION !!! ==> SUBJECT TO CHANGE !!!**

69139	<b>R8 Garcia, Melissa</b>	————— R8 Garcia, Melissa
0	<i>Bye</i>	

## Boys 8 Open 8 - 8 55 Lbs

**!!! CAUTION !!! ==> SUBJECT TO CHANGE !!!**

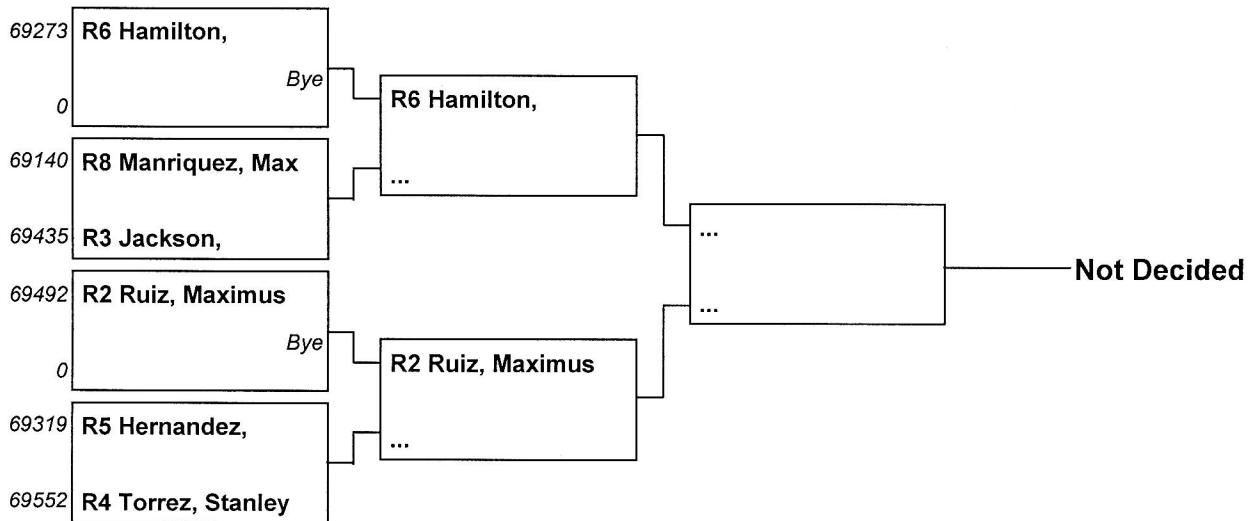

## Boys 8 Open 8 - 8

### 60 Lbs

**!!! CAUTION !!! ==> SUBJECT TO CHANGE !!!**

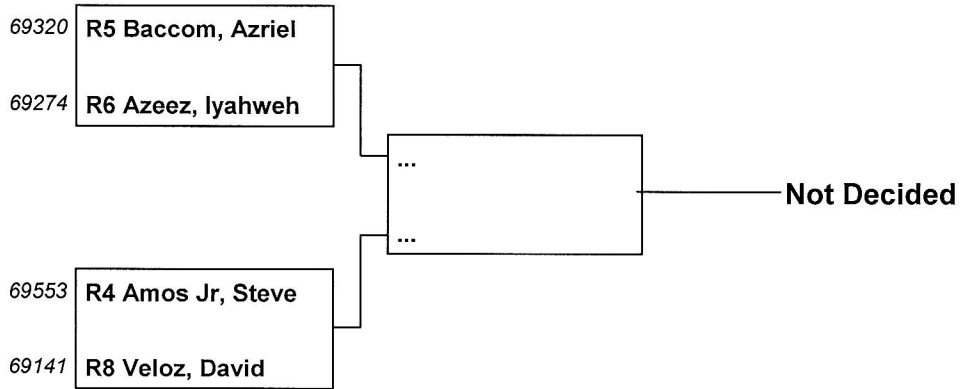

## Girls 8 Open 8 - 8

65 Lbs

**!!! CAUTION !!! ==> SUBJECT TO CHANGE !!!**

69142	R8 Cottrell, Teeko	
0		Bye

————— R8 Cottrell, Teeko

# 2019 National Silver Gloves

Final Bout # 118

## Boys 8 Open 8 - 8

### 65 Lbs

**!!! CAUTION !!! ==> SUBJECT TO CHANGE !!!**

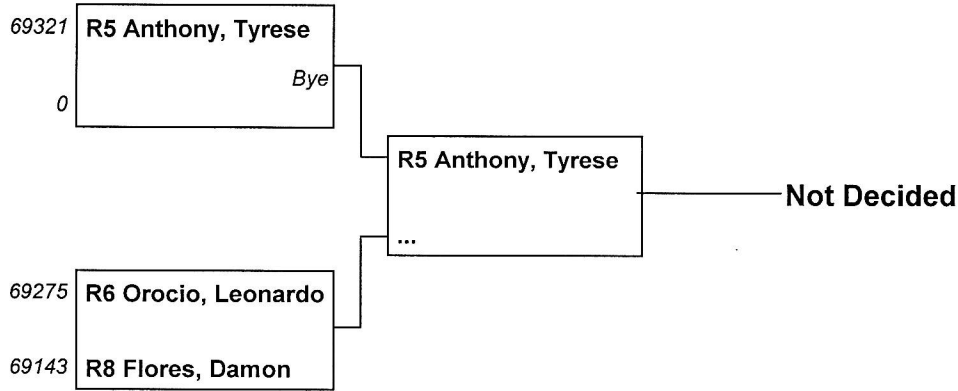

## Girls 8 Open 8 - 8

### 70 Lbs

**!!! CAUTION !!! ==> SUBJECT TO CHANGE !!!**

69145	R8 Arevalos, Aleena	————— R8 Arevalos, Aleena
0	Bye	

# 2019 National Silver Gloves

Final Bout # 121

## Boys 8 Open 8 - 8

### 70 Lbs

**!!! CAUTION !!! ==> SUBJECT TO CHANGE !!!**

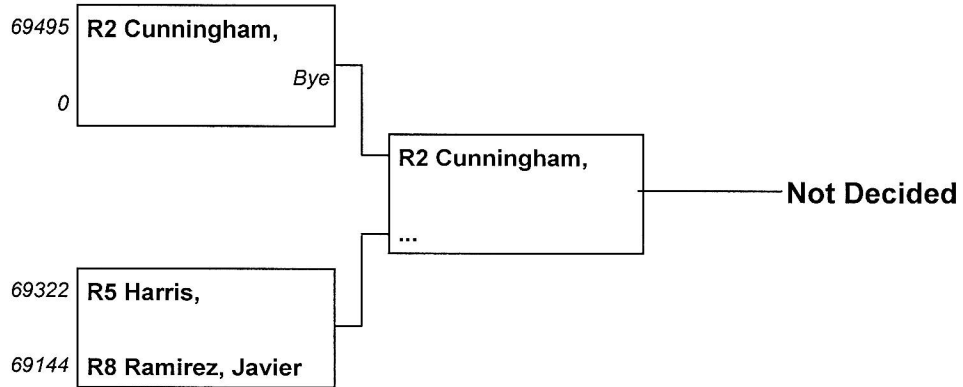



## Boys 8 Open 8 - 8

### 75 Lbs

**!!! CAUTION !!! ==> SUBJECT TO CHANGE !!!**

69555	R4 Labarge, Seth
69378	R1 Carr, Noah

————— Not Decided

## Boys 8 Open 8 - 8

85 Lbs

**!!! CAUTION !!! ==> SUBJECT TO CHANGE !!!**

69324	R5 Rivas, Ramon
69276	R6 Benjamin,

————— Not Decided

## Boys 8 Open 8 - 8

100 Lbs

**!!! CAUTION !!! ==> SUBJECT TO CHANGE !!!**

69436	R3 Brown, Samon	————— Not Decided
69213	R7 Glenn, Wonderful	

## Boys 8 Open 8 - 8

### 106 Lbs

**!!! CAUTION !!! ==> SUBJECT TO CHANGE !!!**

69437	<b>R3 Murray, Christian</b>	————— R3 Murray, Christian
0	<i>Bye</i>	

## Boys 9 - 10 Open 9 - 10 50 Lbs

**!!! CAUTION !!! ==> SUBJECT TO CHANGE !!!**

69215 R7 Ibarra, Leopoldo

69147 R8 Arevalos, Julius

————— Not Decided

## Girls 9 - 10 Open 9 - 10

### 50 Lbs

**!!! CAUTION !!! ==> SUBJECT TO CHANGE !!!**

69146	R8 Arreola, Raquel	
0	Bye	————— R8 Arreola, Raquel

## Boys 9 - 10 Open 9 - 10

### 55 Lbs

### !!! CAUTION !!! ==> SUBJECT TO CHANGE !!!

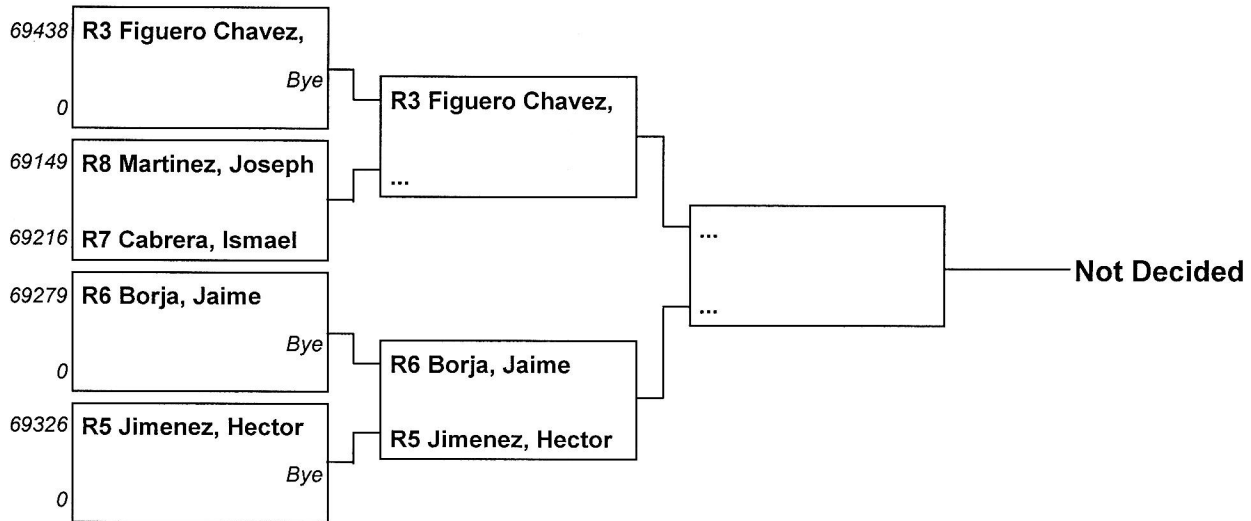

## Girls 9 - 10 Open 9 - 10

### 55 Lbs

### !!! CAUTION !!! ==> SUBJECT TO CHANGE !!!

69148	R8 Martinez,		
0		Bye	————— R8 Martinez, Madellyne



# 2019 National Silver Gloves

Final Bout # 136

## Boys 9 - 10 Open 9 - 10 60 Lbs

**!!! CAUTION !!! ==> SUBJECT TO CHANGE !!!**

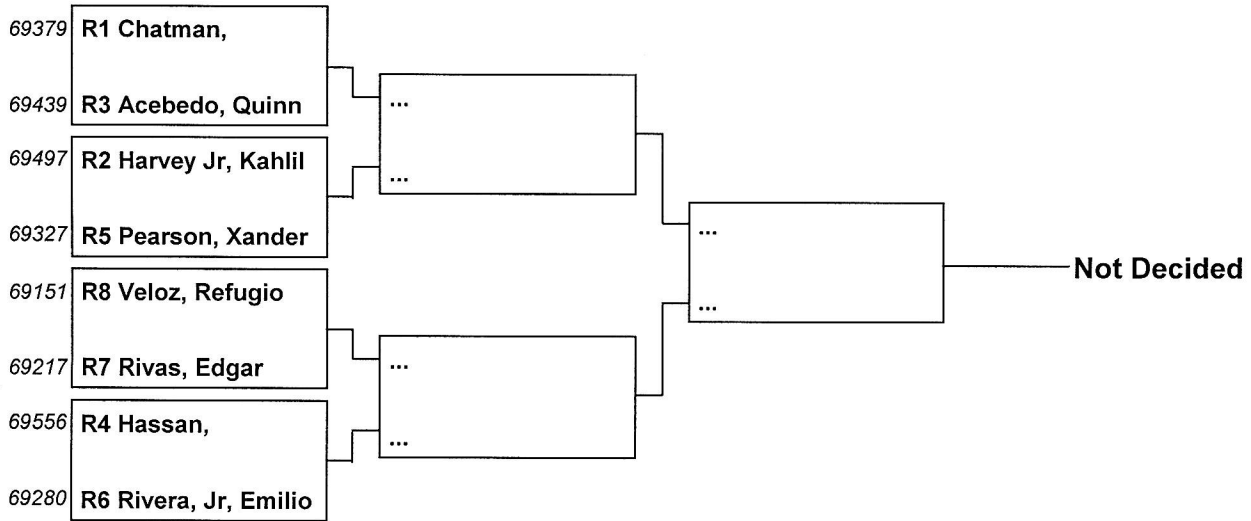

## Girls 9 - 10 Open 9 - 10

### 60 Lbs

### !!! CAUTION !!! ==> SUBJECT TO CHANGE !!!

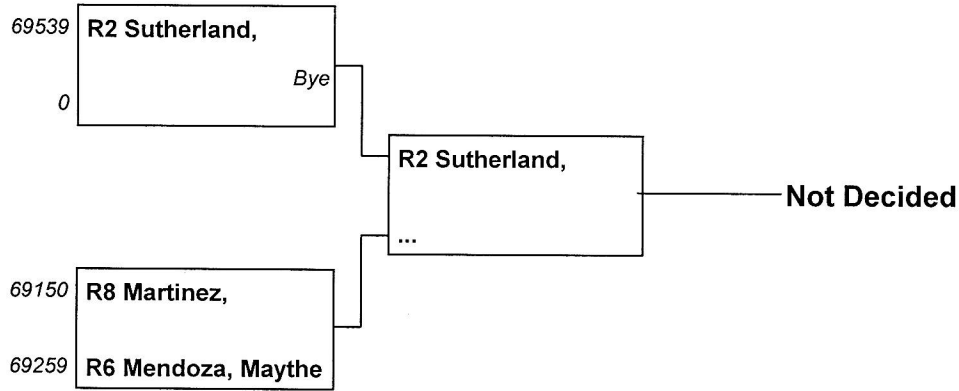

# 2019 National Silver Gloves

Final Bout # 143

## Boys 9 - 10 Open 9 - 10 65 Lbs

**!!! CAUTION !!! ==> SUBJECT TO CHANGE !!!**

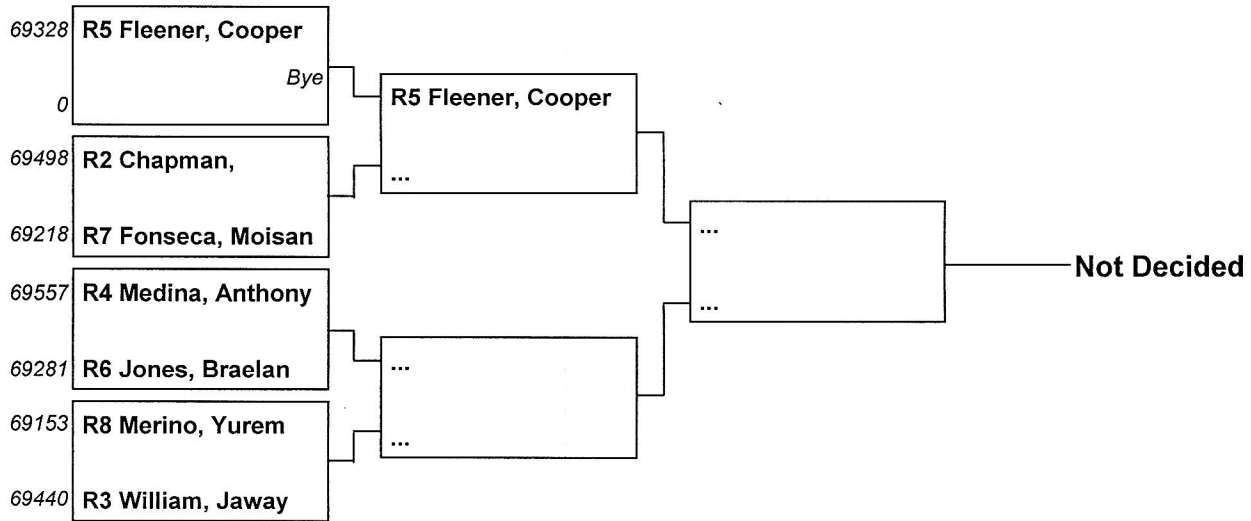

## Girls 9 - 10 Open 9 - 10

### 65 Lbs

**!!! CAUTION !!! ==> SUBJECT TO CHANGE !!!**

69477	R3 Burnios,	————— Not Decided
69609	R5 Vasquez, Selene	

# 2019 National Silver Gloves

Final Bout # 150

## Boys 9 - 10 Open 9 - 10 70 Lbs

**!!! CAUTION !!! ==> SUBJECT TO CHANGE !!!**

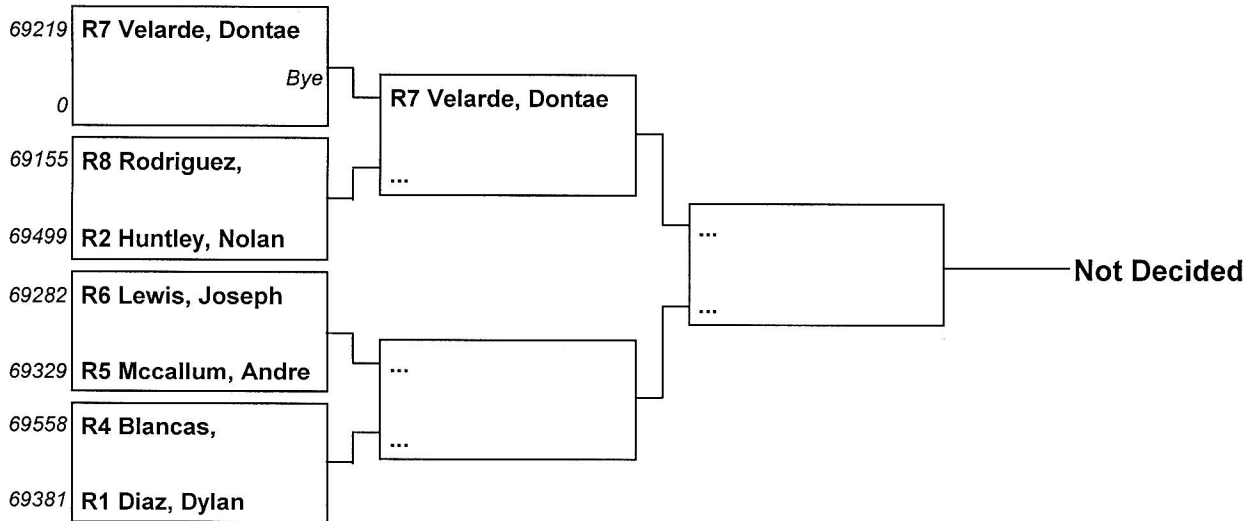

## Girls 9 - 10 Open 9 - 10

### 70 Lbs

**!!! CAUTION !!! ==> SUBJECT TO CHANGE !!!**

69339	R5 Epperson,	————— Not Decided
69154	R8 Moreno, Kayla	

# 2019 National Silver Gloves

Final Bout # 157

## Boys 9 - 10 Open 9 - 10 75 Lbs

**!!! CAUTION !!! ==> SUBJECT TO CHANGE !!!**

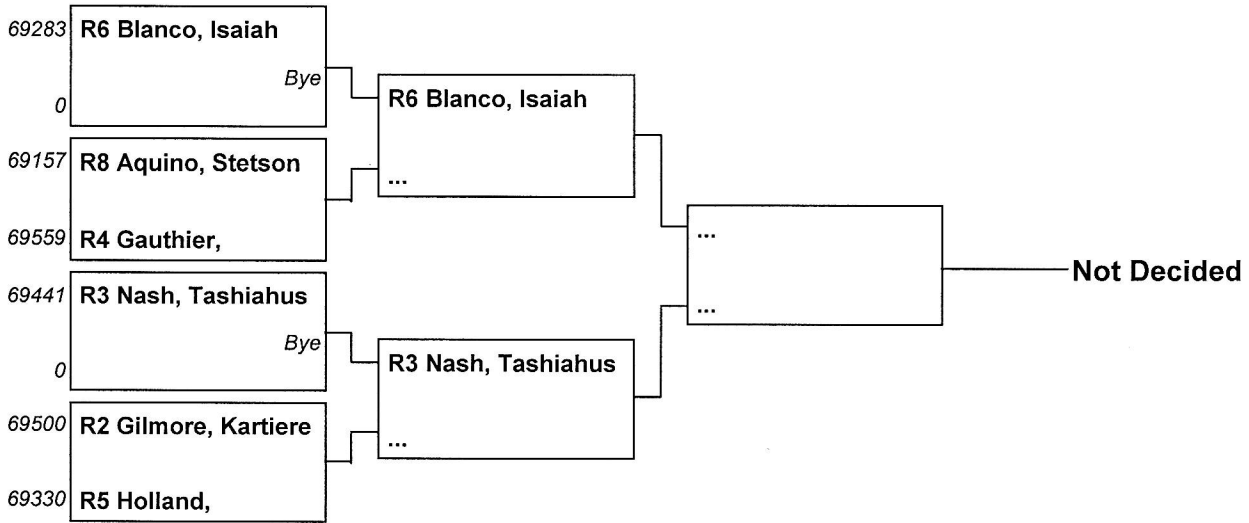

## Girls 9 - 10 Open 9 - 10

### 75 Lbs

### !!! CAUTION !!! ==> SUBJECT TO CHANGE !!!

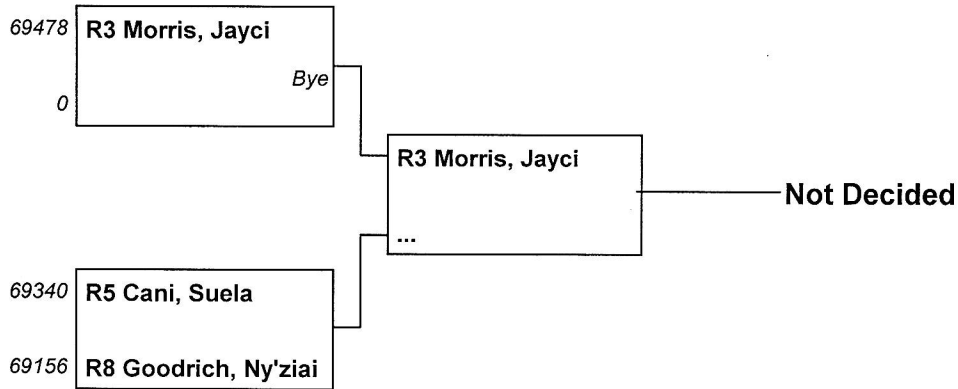



## Boys 9 - 10 Open 9 - 10 80 Lbs

**!!! CAUTION !!! ==> SUBJECT TO CHANGE !!!**

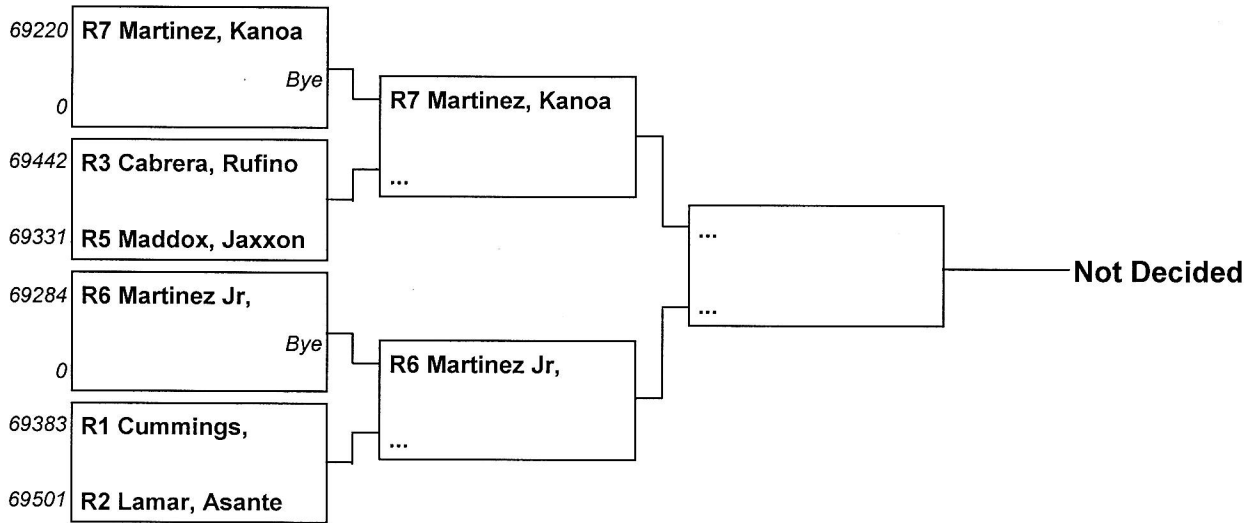

## Girls 9 - 10 Open 9 - 10

### 80 Lbs

### !!! CAUTION !!! ==> SUBJECT TO CHANGE !!!

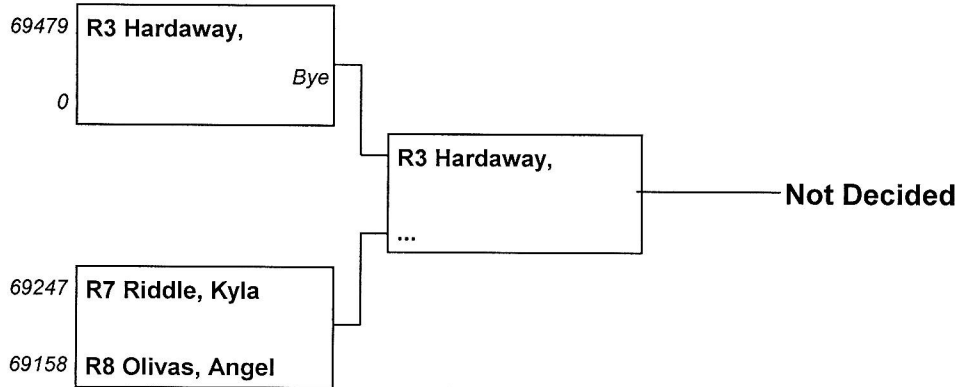

## Boys 9 - 10 Open 9 - 10

### 85 Lbs

**!!! CAUTION !!! ==> SUBJECT TO CHANGE !!!**

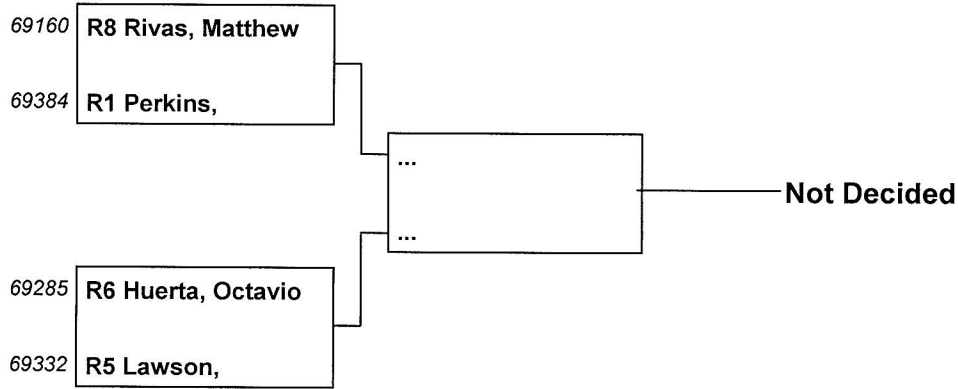

## Girls 9 - 10 Open 9 - 10

85 Lbs

**!!! CAUTION !!! ==> SUBJECT TO CHANGE !!!**

69593	R4 O'kimash,	————— Not Decided
69248	R7 Martinez,	

## Boys 9 - 10 Open 9 - 10 90 Lbs

**!!! CAUTION !!! ==> SUBJECT TO CHANGE !!!**

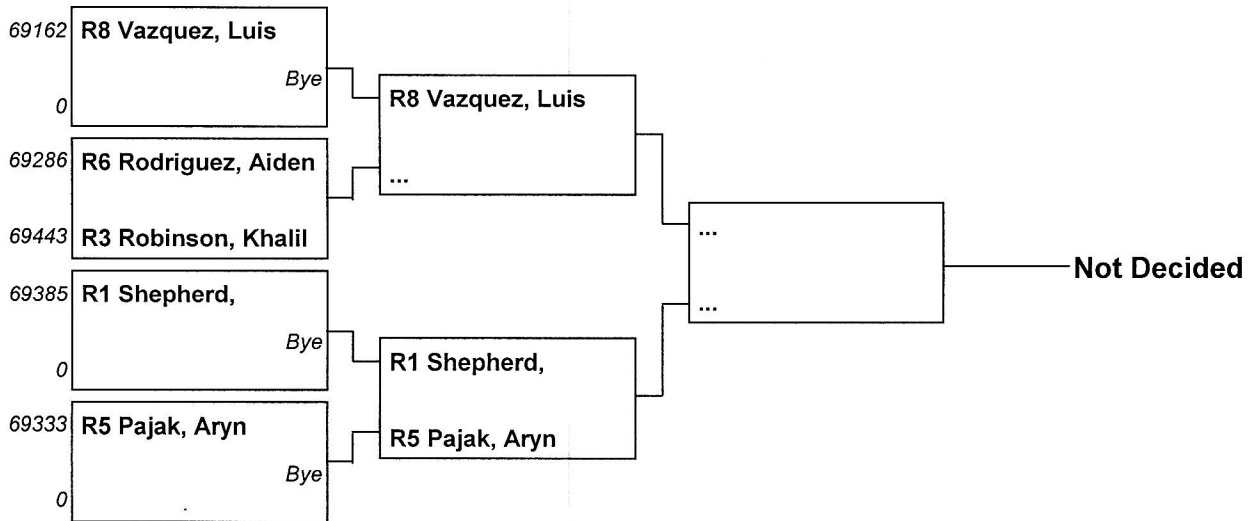

## Girls 9 - 10 Open 9 - 10

90 Lbs

**!!! CAUTION !!! ==> SUBJECT TO CHANGE !!!**

69167 R8 Gutierrez, Giselle

69249 R7 Well Known,

Not Decided

## Boys 9 - 10 Open 9 - 10

### 95 Lbs

### !!! CAUTION !!! ==> SUBJECT TO CHANGE !!!

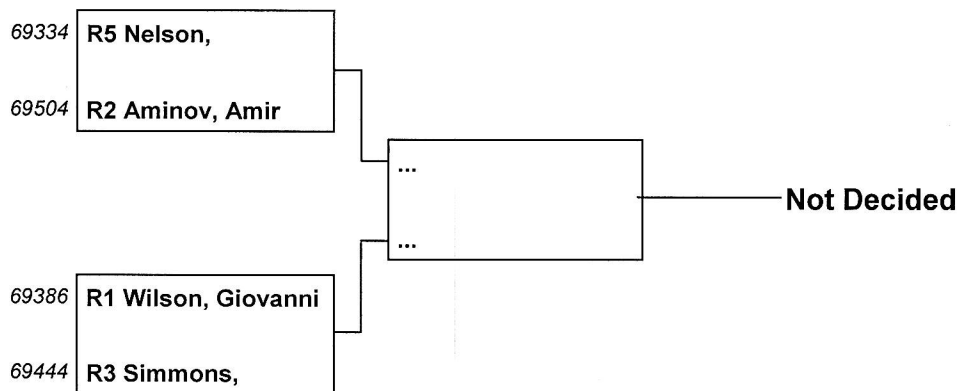

## Girls 9 - 10 Open 9 - 10

### 95 Lbs

**!!! CAUTION !!! ==> SUBJECT TO CHANGE !!!**

69250	<b>R7 Chartier, Kaylee</b>	————— R7 Chartier, Kaylee
0	<i>Bye</i>	



## Boys 9 - 10 Open 9 - 10

### 100 Lbs

**!!! CAUTION !!! ==> SUBJECT TO CHANGE !!!**

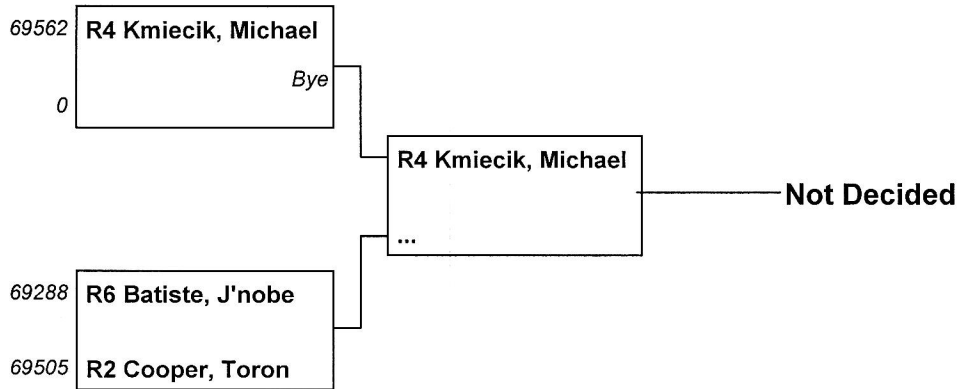

## Girls 9 - 10 Open 9 - 10

### 100 Lbs

**!!! CAUTION !!! ==> SUBJECT TO CHANGE !!!**

69163	<b>R8 Sota, Melaya</b>	Bye	R8 Sota, Melaya
0			

## Boys 9 - 10 Open 9 - 10

### 106 Lbs

**!!! CAUTION !!! ==> SUBJECT TO CHANGE !!!**

69335	R5 Gaspariano,		
0		Bye	————— R5 Gaspariano, Ricardo

## Boys 9 - 10 Open 9 - 10

### 110 Lbs

### !!! CAUTION !!! ==> SUBJECT TO CHANGE !!!

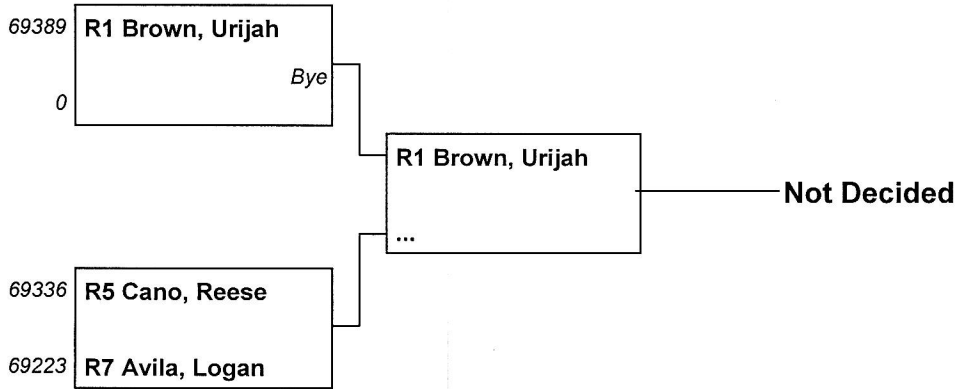

## Boys 9 - 10 Open 9 - 10

### 114 Lbs

**!!! CAUTION !!! ==> SUBJECT TO CHANGE !!!**

69506	R2 Carter, Tolley	
0		Bye

————— R2 Carter, Tolley

## Boys 9 - 10 Open 9 - 10

### 119 Lbs

### !!! CAUTION !!! ==> SUBJECT TO CHANGE !!!

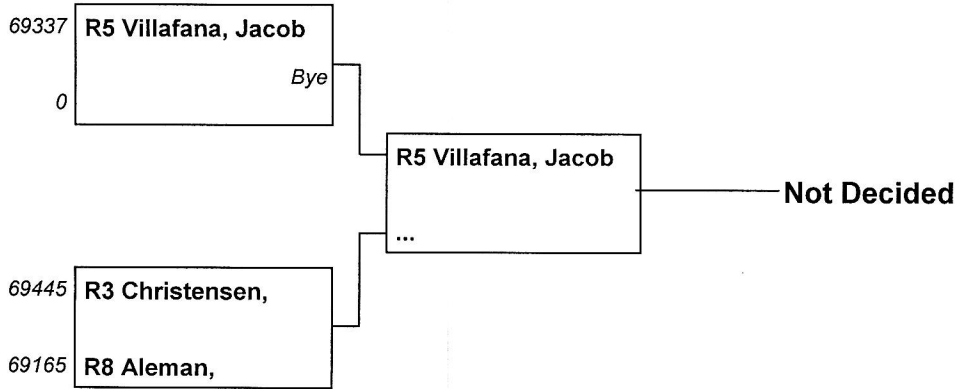

## Boys 9 - 10 Open 9 - 10

### 125 Lbs

# !!! CAUTION !!! ==> SUBJECT TO CHANGE !!!

69166	R8 Mercado, Diego	
0		Bye

————— R8 Mercado, Diego

## Boys 9 - 10 Open 9 - 10

### 138 Lbs

**!!! CAUTION !!! ==> SUBJECT TO CHANGE !!!**

69446	R3 Drummond,		
0		Bye	————— R3 Drummond, Thomas





## Boys 9 - 10 Open 9 - 10

154 Lbs

**!!! CAUTION !!! ==> SUBJECT TO CHANGE !!!**

69224	<b>R7 Padilla, Jernee</b>
0	Bye

————— **R7 Padilla, Jernee**

## Girls 11 - 12 Open 11 - 12 65 Lbs

**!!! CAUTION !!! ==> SUBJECT TO CHANGE !!!**

69261	R6 Zuniga, Angela	————— Not Decided
69167	R8 Bobadilla,	

## Boys 11 - 12 Open 11 - 12 65 Lbs

**!!! CAUTION !!! ==> SUBJECT TO CHANGE !!!**

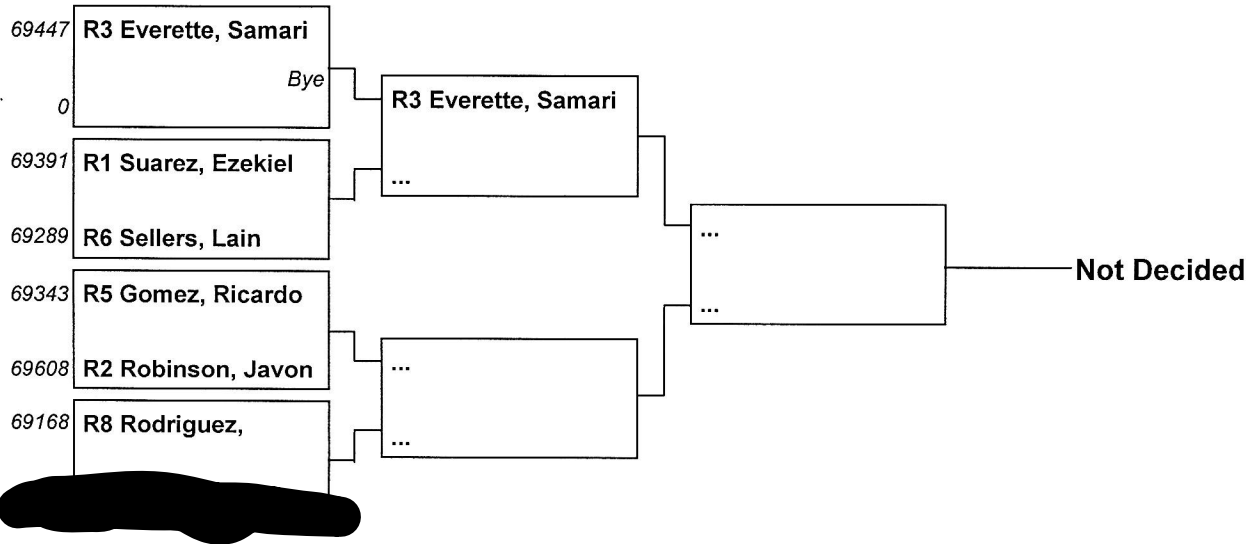

## Girls 11 - 12 Open 11 - 12 70 Lbs

**!!! CAUTION !!! ==> SUBJECT TO CHANGE !!!**

69540	R2 Robinson, Lily
69169	R8 Vejar, Selene

————— Not Decided

# 2019 National Silver Gloves

Final Bout # 205

## Boys 11 - 12 Open 11 - 12 70 Lbs

**!!! CAUTION !!! ==> SUBJECT TO CHANGE !!!**

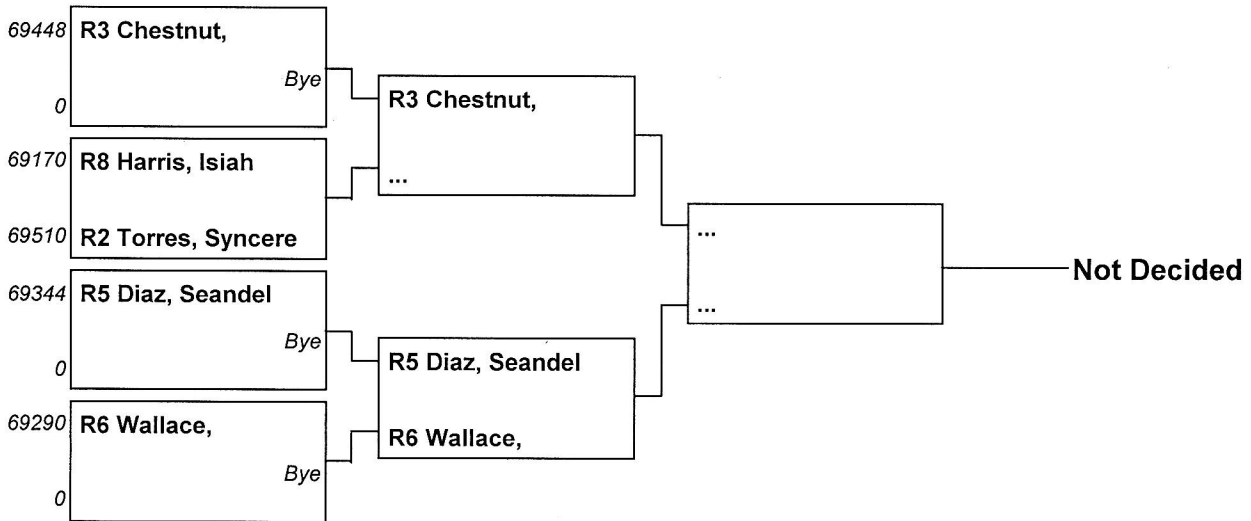

## Girls 11 - 12 Open 11 - 12

75 Lbs

**!!! CAUTION !!! ==> SUBJECT TO CHANGE !!!**

69171	R8 Gonzalez,	————— Not Decided
69262	R6 Hernandez,	

# 2019 National Silver Gloves

Final Bout # 212

## Boys 11 - 12 Open 11 - 12 75 Lbs

**!!! CAUTION !!! ==> SUBJECT TO CHANGE !!!**

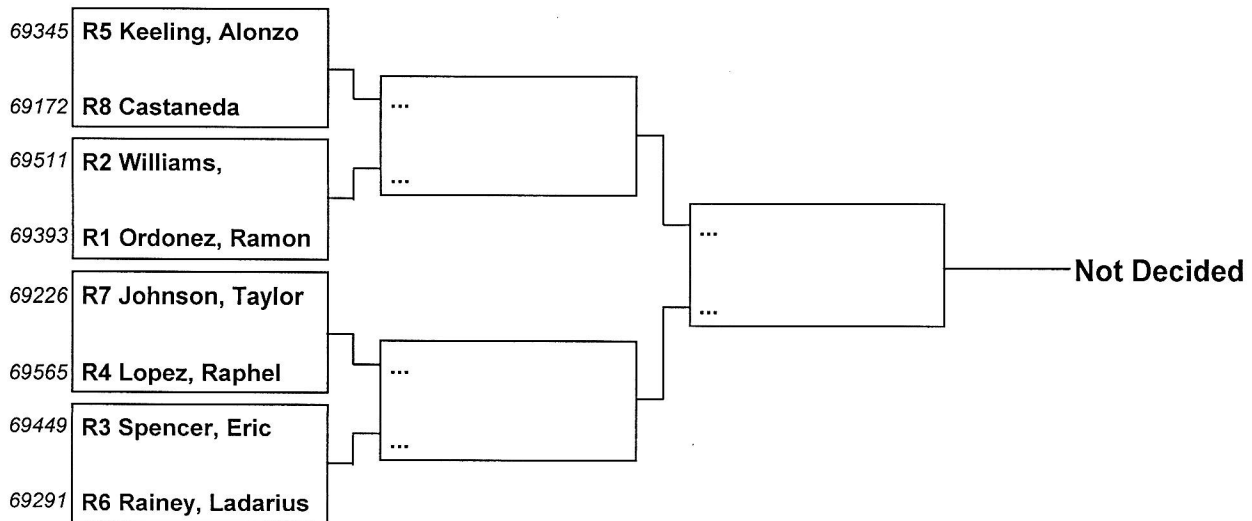

## Girls 11 - 12 Open 11 - 12

### 80 Lbs

### !!! CAUTION !!! ==> SUBJECT TO CHANGE !!!

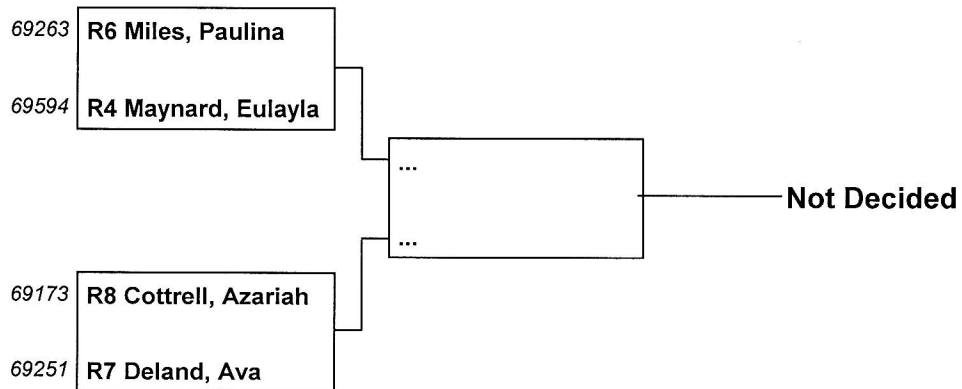



# 2019 National Silver Gloves

Final Bout # 219

## Boys 11 - 12 Open 11 - 12 80 Lbs

**!!! CAUTION !!! ==> SUBJECT TO CHANGE !!!**

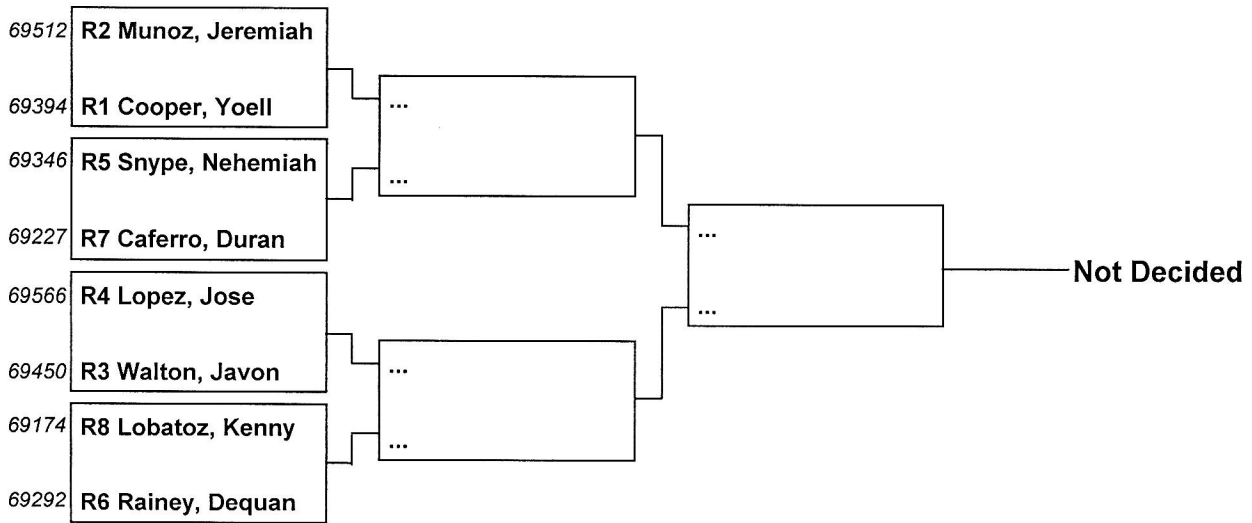

## Girls 11 - 12 Open 11 - 12

### 85 Lbs

### !!! CAUTION !!! ==> SUBJECT TO CHANGE !!!

69595	R4 Gudino, Araceli		R4 Gudino, Araceli
0		Bye	

# 2019 National Silver Gloves

Final Bout # 226

## Boys 11 - 12 Open 11 - 12

### 85 Lbs

**!!! CAUTION !!! ==> SUBJECT TO CHANGE !!!**

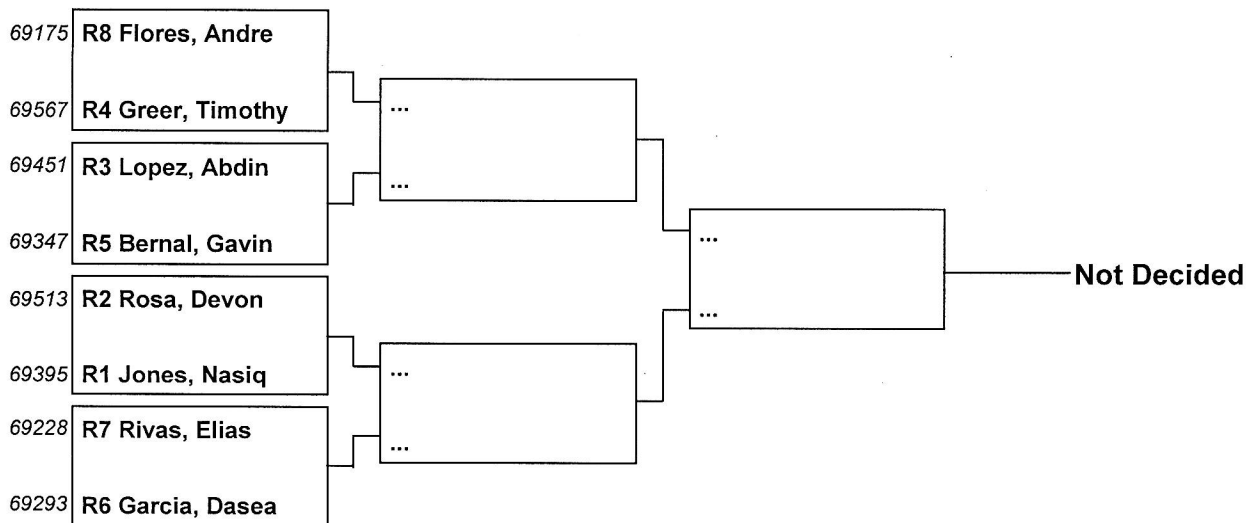

## Girls 11 - 12 Open 11 - 12

90 Lbs

**!!! CAUTION !!! ==> SUBJECT TO CHANGE !!!**

69264	R6 Ramirez,	————— Not Decided
69176	R8 Samorano, Alysa	

## Boys 11 - 12 Open 11 - 12 90 Lbs

**!!! CAUTION !!! ==> SUBJECT TO CHANGE !!!**

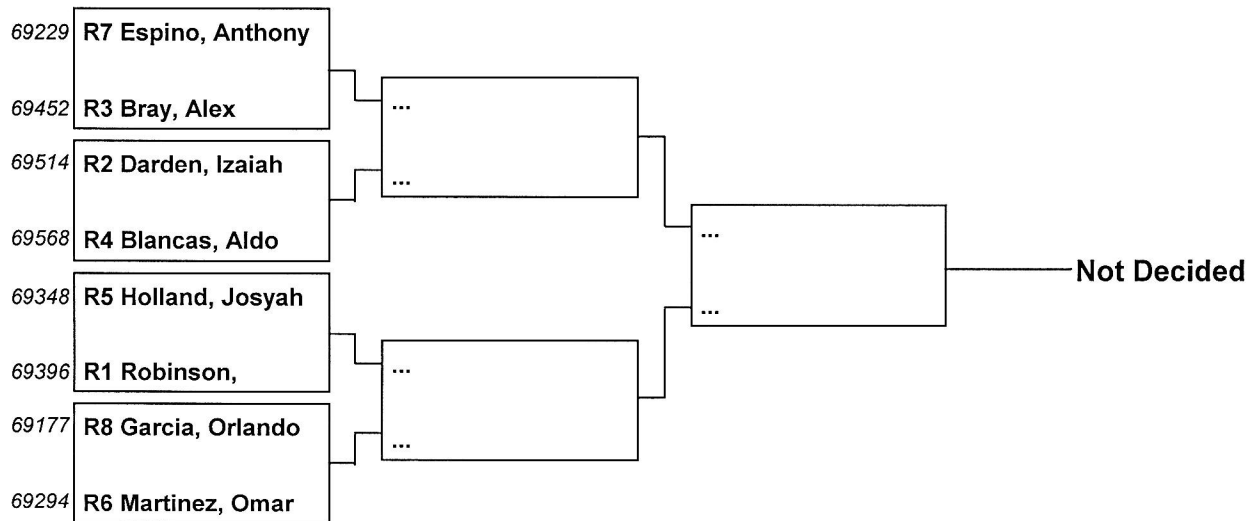

## Girls 11 - 12 Open 11 - 12

### 95 Lbs

**!!! CAUTION !!! ==> SUBJECT TO CHANGE !!!**

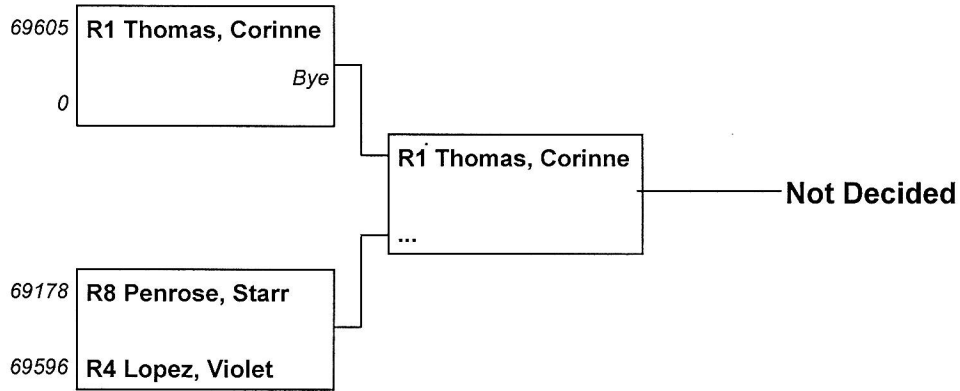

# 2019 National Silver Gloves

Final Bout # 240

## Boys 11 - 12 Open 11 - 12 95 Lbs

**!!! CAUTION !!! ==> SUBJECT TO CHANGE !!!**

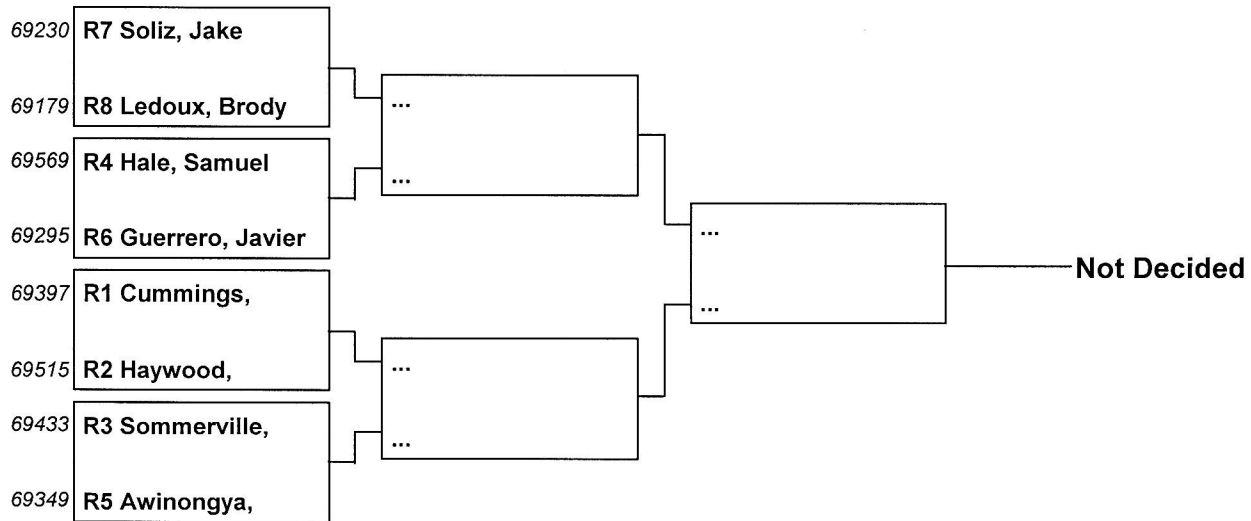

## Girls 11 - 12 Open 11 - 12

### 100 Lbs

### !!! CAUTION !!! ==> SUBJECT TO CHANGE !!!

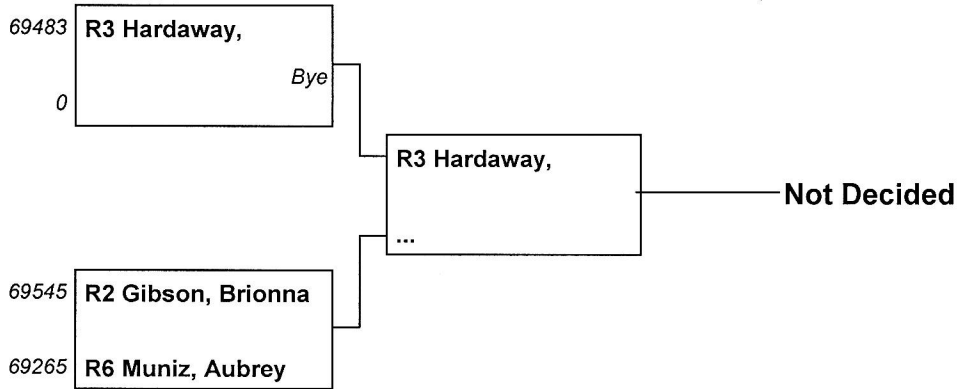



## Boys 11 - 12 Open 11 - 12 100 Lbs

**!!! CAUTION !!! ==> SUBJECT TO CHANGE !!!**

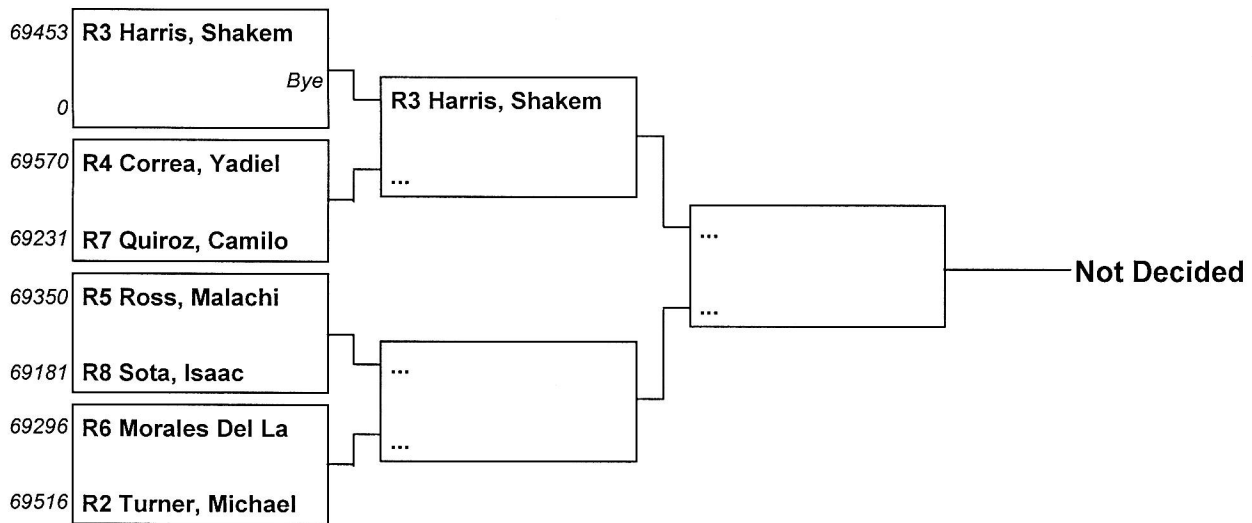

## Girls 11 - 12 Open 11 - 12

106 Lbs

**!!! CAUTION !!! ==> SUBJECT TO CHANGE !!!**

69266	R6 Flores, Solana	————— Not Decided
69356	R5 Russian, Nevaeh	

## Boys 11 - 12 Open 11 - 12 106 Lbs

**!!! CAUTION !!! ==> SUBJECT TO CHANGE !!!**

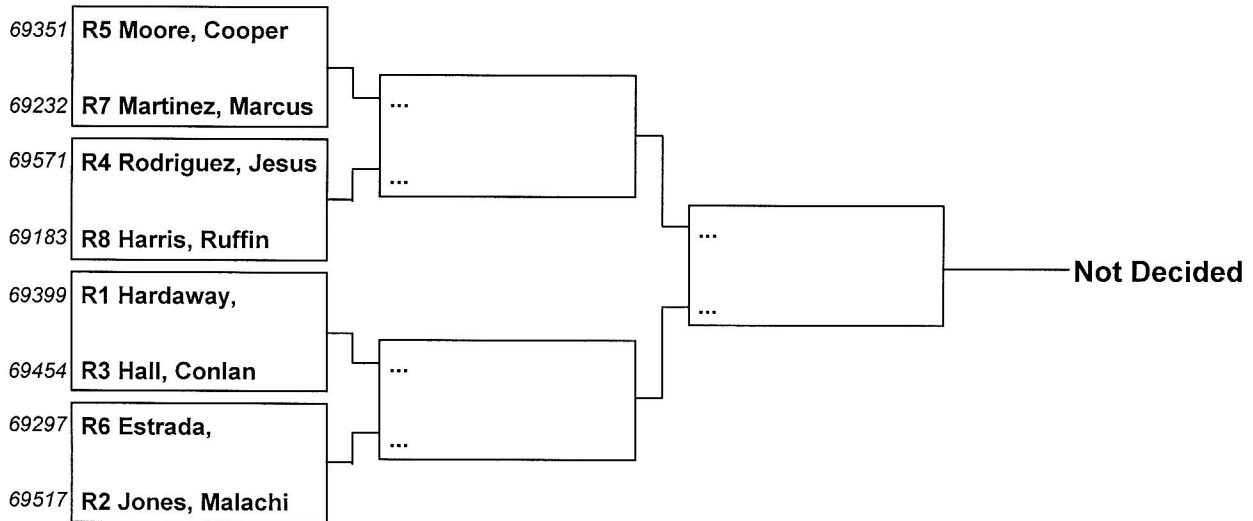

## Girls 11 - 12 Open 11 - 12

### 110 Lbs

### !!! CAUTION !!! ==> SUBJECT TO CHANGE !!!

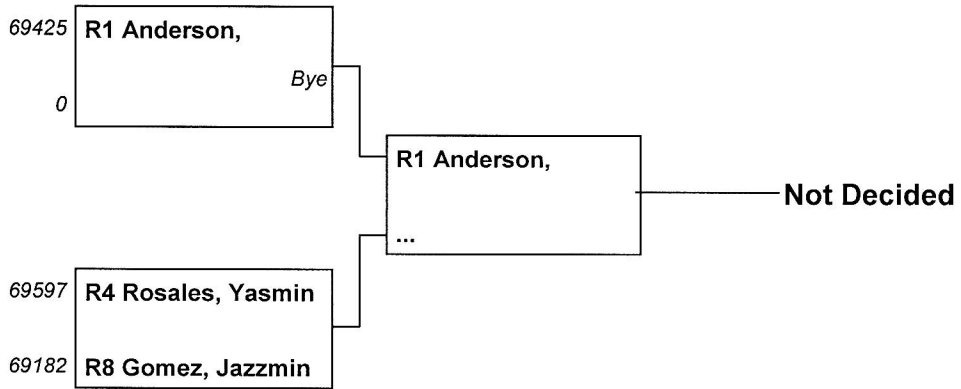

## Boys 11 - 12 Open 11 - 12

### 110 Lbs

**!!! CAUTION !!! ==> SUBJECT TO CHANGE !!!**

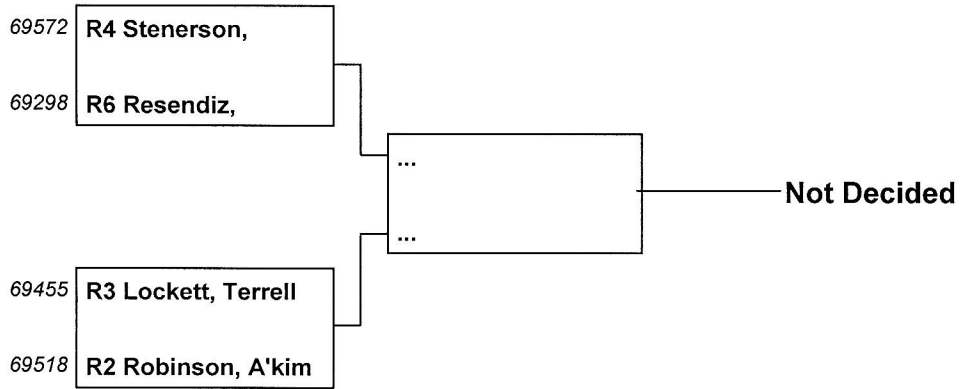

## Boys 11 - 12 Open 11 - 12

### 114 Lbs

**!!! CAUTION !!! ==> SUBJECT TO CHANGE !!!**

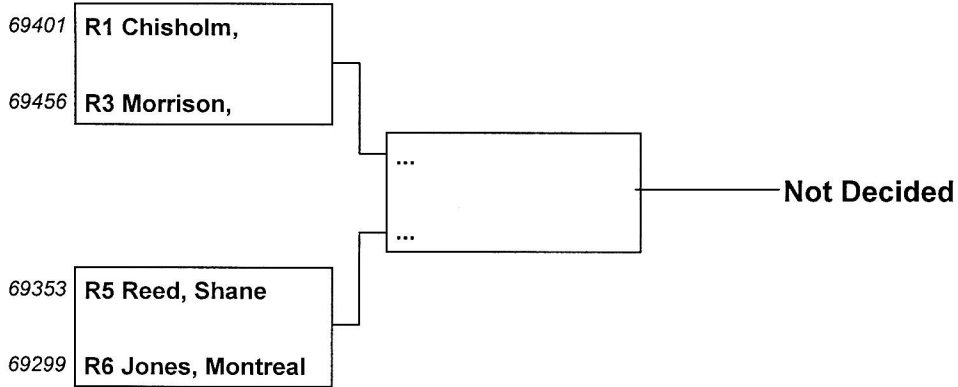

## Boys 11 - 12 Open 11 - 12 119 Lbs

**!!! CAUTION !!! ==> SUBJECT TO CHANGE !!!**

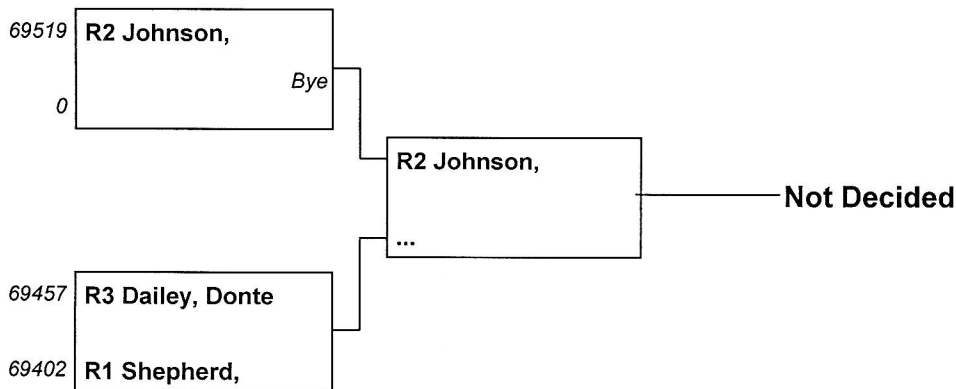

## Boys 11 - 12 Open 11 - 12

### 125 Lbs

### !!! CAUTION !!! ==> SUBJECT TO CHANGE !!!

69458	R3 Lugo, Elijah	————— Not Decided
69403	R1 Session,	



## Girls 11 - 12 Open 11 - 12

### 132 Lbs

### !!! CAUTION !!! ==> SUBJECT TO CHANGE !!!

69547	R2 Murray, Ja'mya	
0		Bye

————— R2 Murray, Ja'mya

## Boys 11 - 12 Open 11 - 12

### 132 Lbs

**!!! CAUTION !!! ==> SUBJECT TO CHANGE !!!**

69185	R8 Felix, Siomar
69300	R6 Duran, Seth

————— Not Decided

## Boys 11 - 12 Open 11 - 12

138 Lbs

**!!! CAUTION !!! ==> SUBJECT TO CHANGE !!!**

69521	R2 Aroche, Marlon
69405	R1 Summers,

Not Decided

## Boys 11 - 12 Open 11 - 12

145 Lbs

**!!! CAUTION !!! ==> SUBJECT TO CHANGE !!!**

69459	R3 Baskett, Deondre	————— Not Decided
69235	R7 Hunt, Caden	

## Boys 11 - 12 Open 11 - 12 165 Lbs

**!!! CAUTION !!! ==> SUBJECT TO CHANGE !!!**

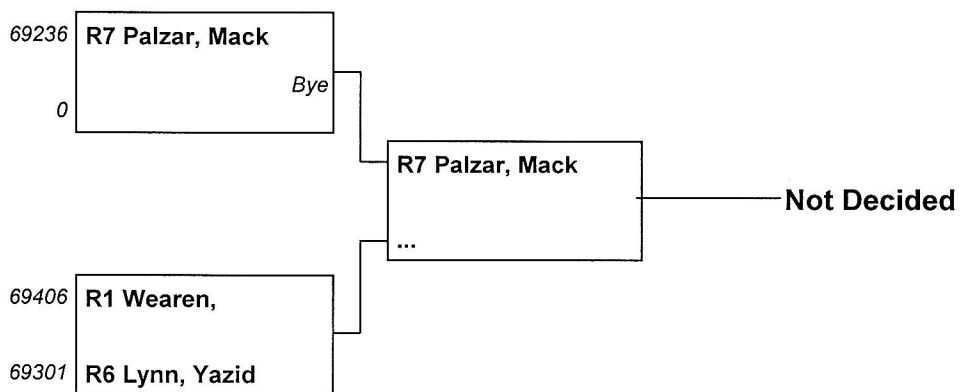

## Girls 11 - 12 Open 11 - 12

### 201 Lbs

**!!! CAUTION !!! ==> SUBJECT TO CHANGE !!!**

69267	R6 Kelley, Zamila	————— R6 Kelley, Zamila
0	Bye	

## Boys 11 - 12 Open 11 - 12

### 201 Lbs

**!!! CAUTION !!! ==> SUBJECT TO CHANGE !!!**

69460	R3 Pitts, Tyson	Bye	R3 Pitts, Tyson
0			

## Boys 13 - 14 Open 13 - 14

### 65 Lbs

**!!! CAUTION !!! ==> SUBJECT TO CHANGE !!!**

69522	R2 Rainey, Kamauri	————— R2 Rainey, Kamauri
0	Bye	



# 2019 National Silver Gloves

Final Bout # 279

## Boys 13 - 14 Open 13 - 14 75 Lbs

**!!! CAUTION !!! ==> SUBJECT TO CHANGE !!!**

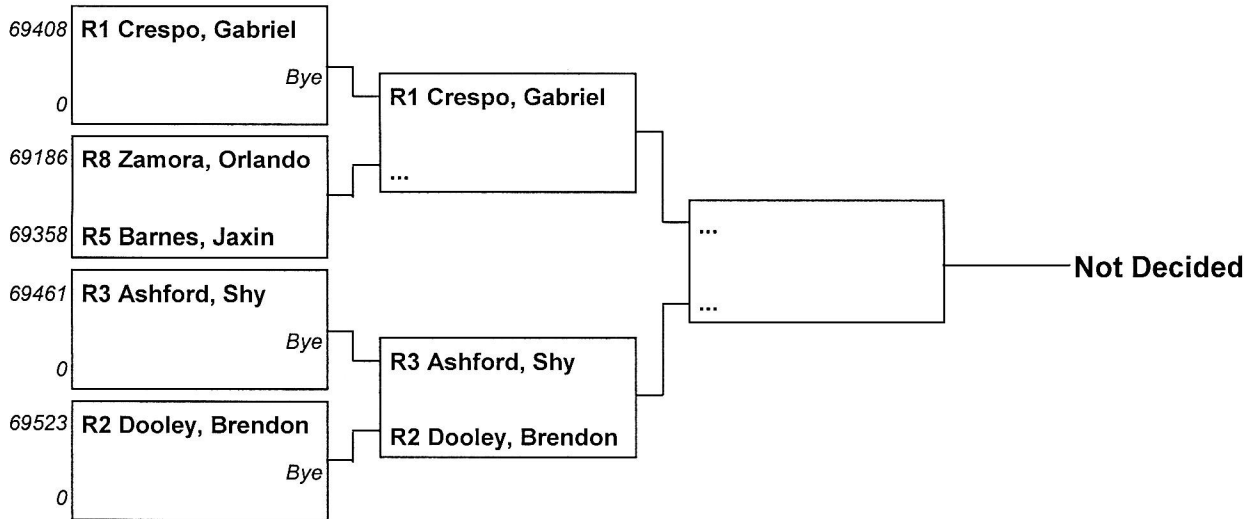

## Girls 13 - 14 Open 13 - 14

### 80 Lbs

**!!! CAUTION !!! ==> SUBJECT TO CHANGE !!!**

69485	R3 Lee, Teersa	Bye	R3 Lee, Teersa
0			

# 2019 National Silver Gloves

Final Bout # 286

## Boys 13 - 14 Open 13 - 14 80 Lbs

**!!! CAUTION !!! ==> SUBJECT TO CHANGE !!!**

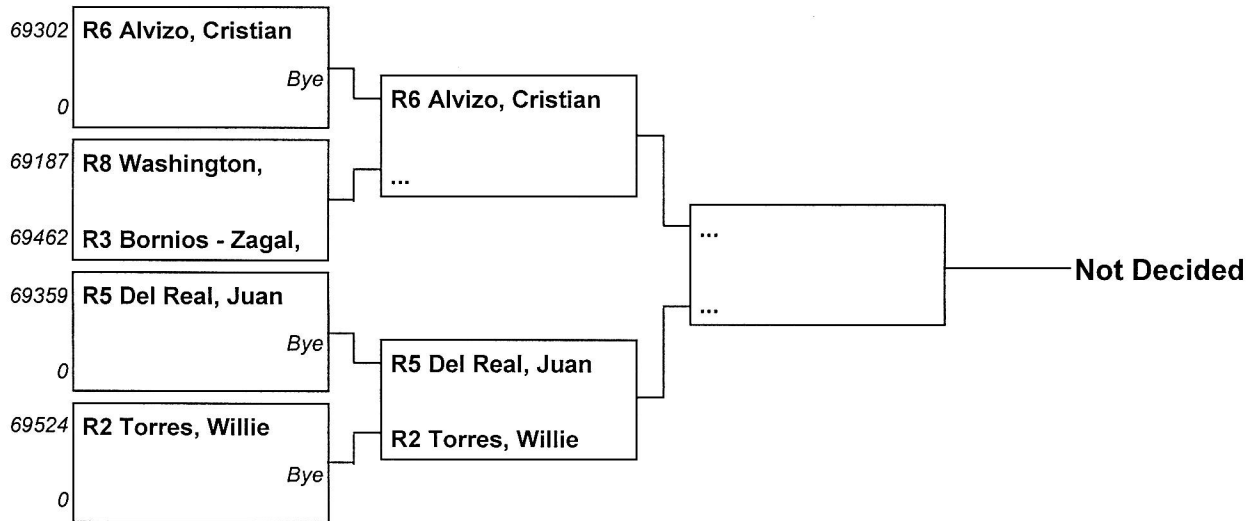

## Girls 13 - 14 Open 13 - 14

### 85 Lbs

**!!! CAUTION !!! ==> SUBJECT TO CHANGE !!!**

69355	R5 Fleener, Madelyn	
0		Bye

————— R5 Fleener, Madelyn

# 2019 National Silver Gloves

Final Bout # 293

## Boys 13 - 14 Open 13 - 14 85 Lbs

**!!! CAUTION !!! ==> SUBJECT TO CHANGE !!!**

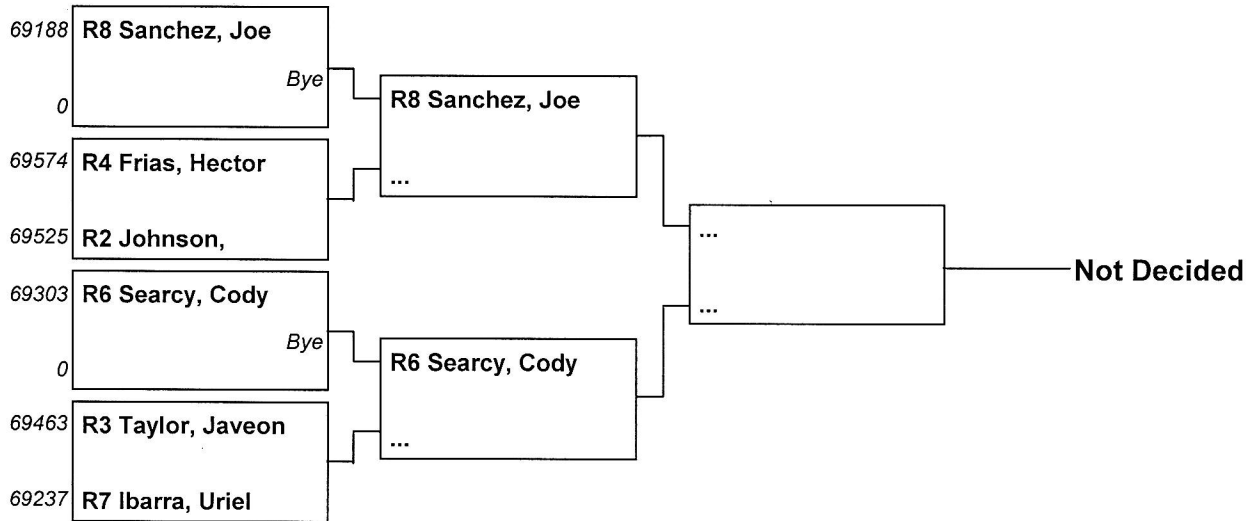

## Girls 13 - 14 Open 13 - 14

### 90 Lbs

### !!! CAUTION !!! ==> SUBJECT TO CHANGE !!!

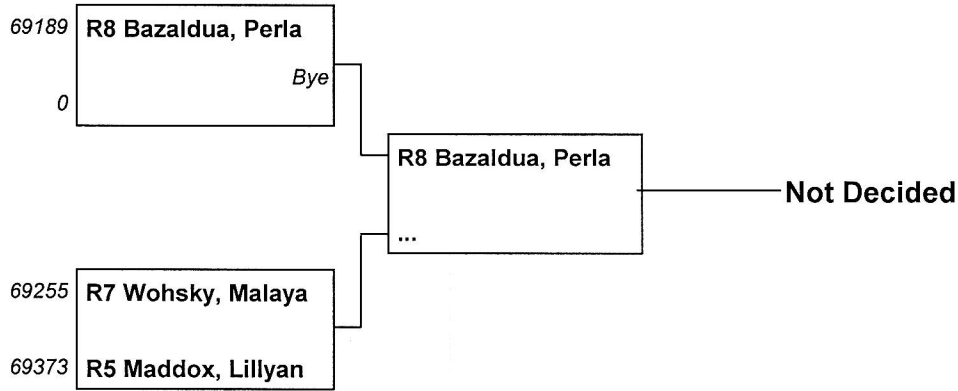

# 2019 National Silver Gloves

Final Bout # 300

## Boys 13 - 14 Open 13 - 14 90 Lbs

**!!! CAUTION !!! ==> SUBJECT TO CHANGE !!!**

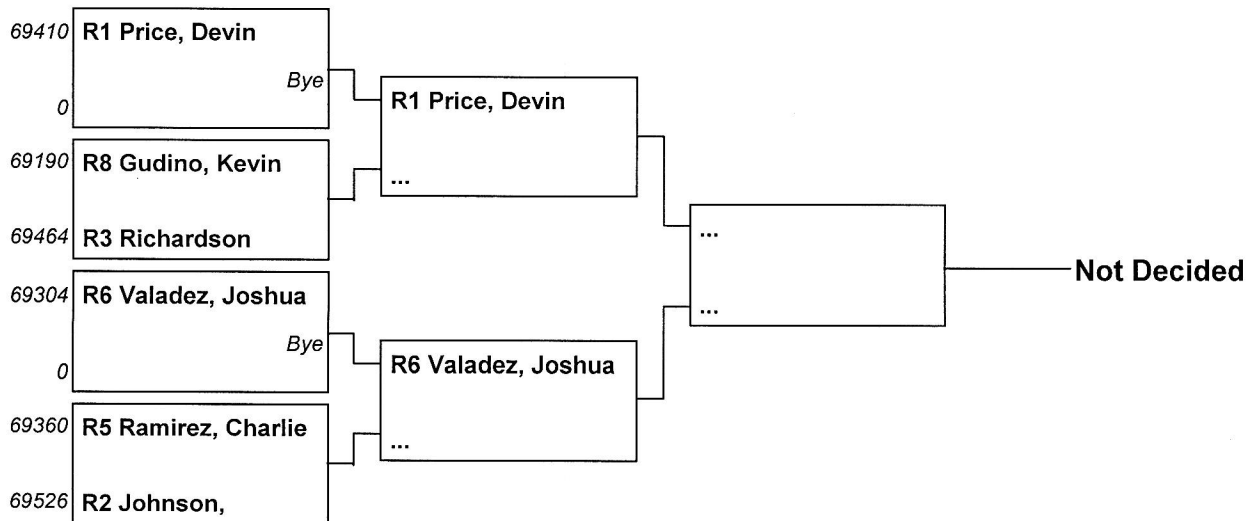

## Girls 13 - 14 Open 13 - 14

### 95 Lbs

**!!! CAUTION !!! ==> SUBJECT TO CHANGE !!!**

69268	R6 Orozco, Noely	————— Not Decided
69191	R8 Bahe, Mariah	



# 2019 National Silver Gloves

Final Bout # 307

## Boys 13 - 14 Open 13 - 14 95 Lbs

**!!! CAUTION !!! ==> SUBJECT TO CHANGE !!!**

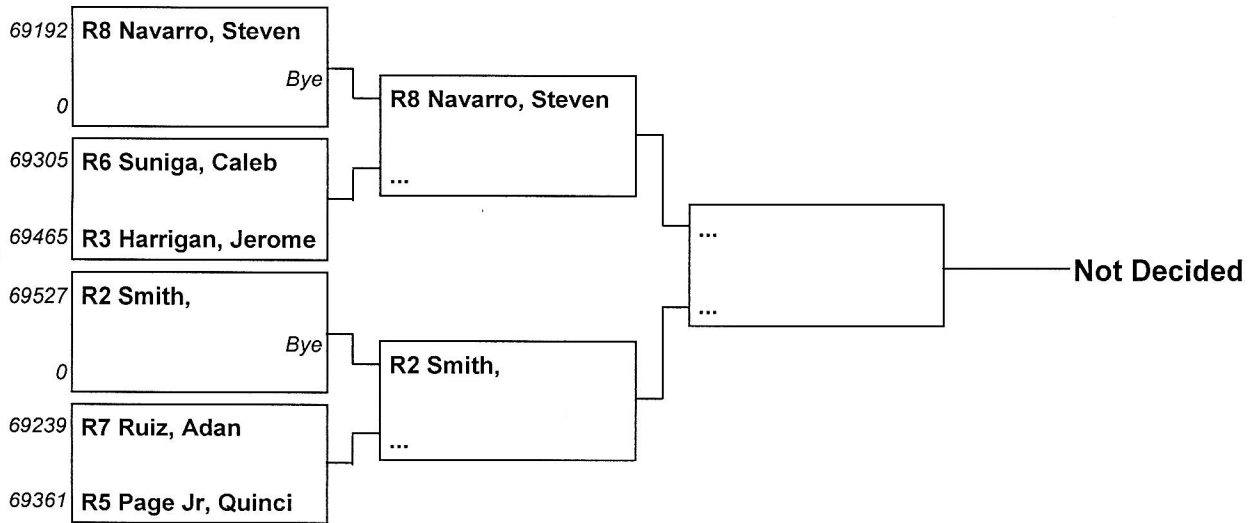

## Girls 13 - 14 Open 13 - 14 100 Lbs

**!!! CAUTION !!! ==> SUBJECT TO CHANGE !!!**

69193	R8 Martinez, Mariah
69269	R6 Salazar, Sindi

————— Not Decided

# 2019 National Silver Gloves

Final Bout # 314

## Boys 13 - 14 Open 13 - 14 100 Lbs

**!!! CAUTION !!! ==> SUBJECT TO CHANGE !!!**

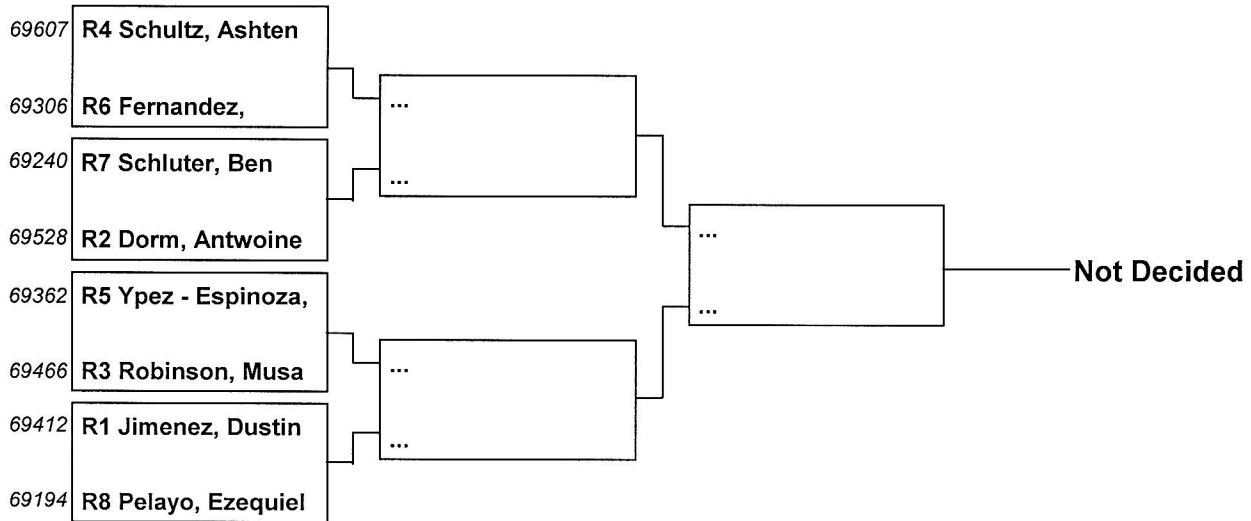

## Girls 13 - 14 Open 13 - 14

### 106 Lbs

### !!! CAUTION !!! ==> SUBJECT TO CHANGE !!!

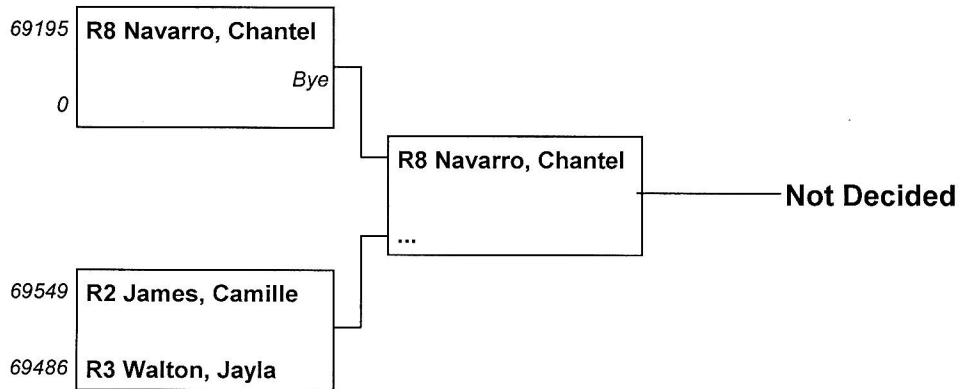

# 2019 National Silver Gloves

Final Bout # 345

## Boys 13 - 14 Open 13 - 14 106 Lbs

**!!! CAUTION !!! ==> SUBJECT TO CHANGE !!!**

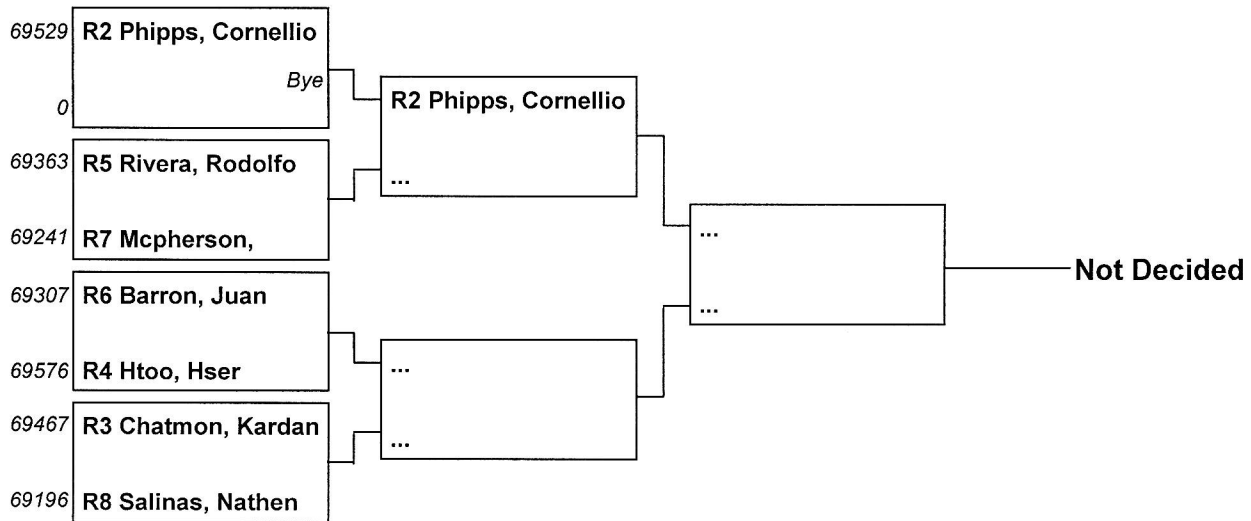

# 2019 National Silver Gloves

Final Bout # 433

## Girls 13 - 14 Open 13 - 14 110 Lbs

**!!! CAUTION !!! ==> SUBJECT TO CHANGE !!!**

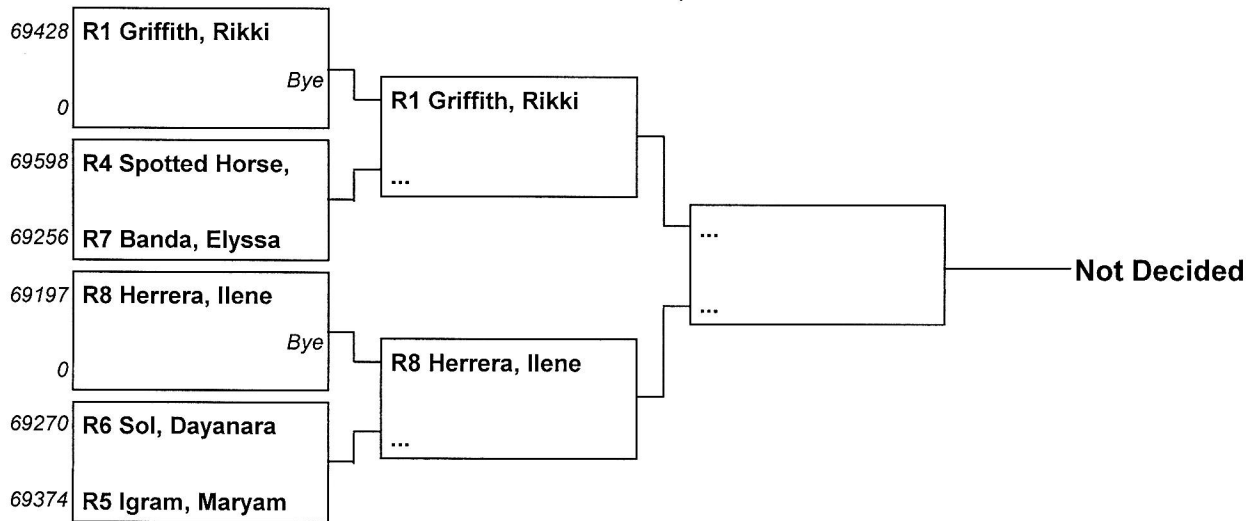

# 2019 National Silver Gloves

Final Bout # 321

## Boys 13 - 14 Open 13 - 14 110 Lbs

**!!! CAUTION !!! ==> SUBJECT TO CHANGE !!!**

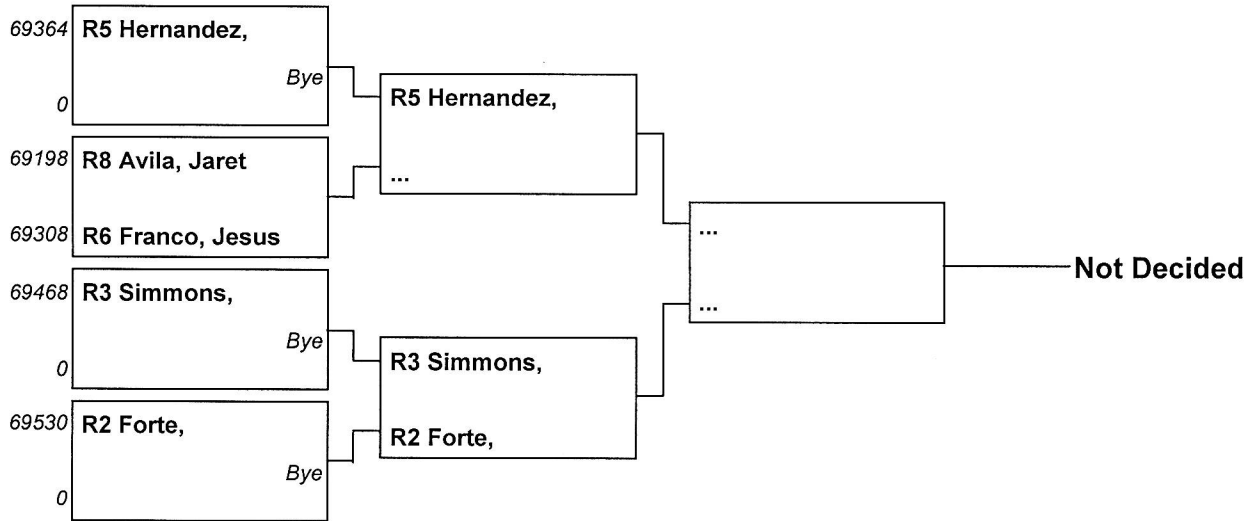

## Girls 13 - 14 Open 13 - 14 114 Lbs

**!!! CAUTION !!! ==> SUBJECT TO CHANGE !!!**

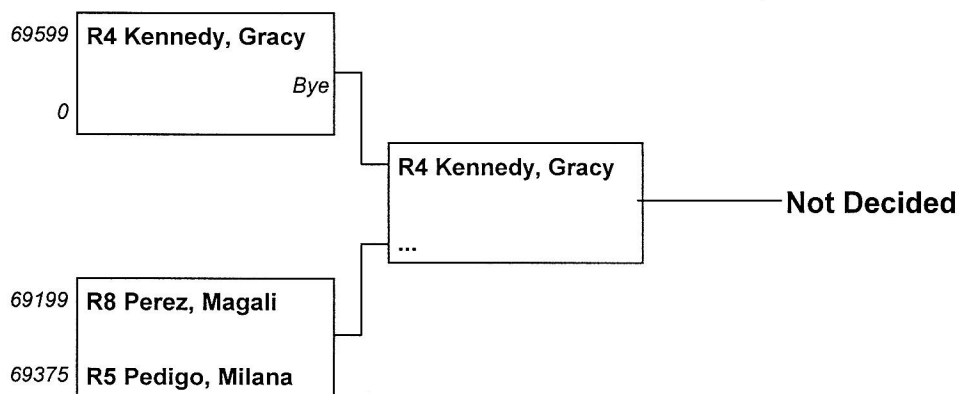



# 2019 National Silver Gloves

Final Bout # 379

## Boys 13 - 14 Open 13 - 14 114 Lbs

**!!! CAUTION !!! ==> SUBJECT TO CHANGE !!!**

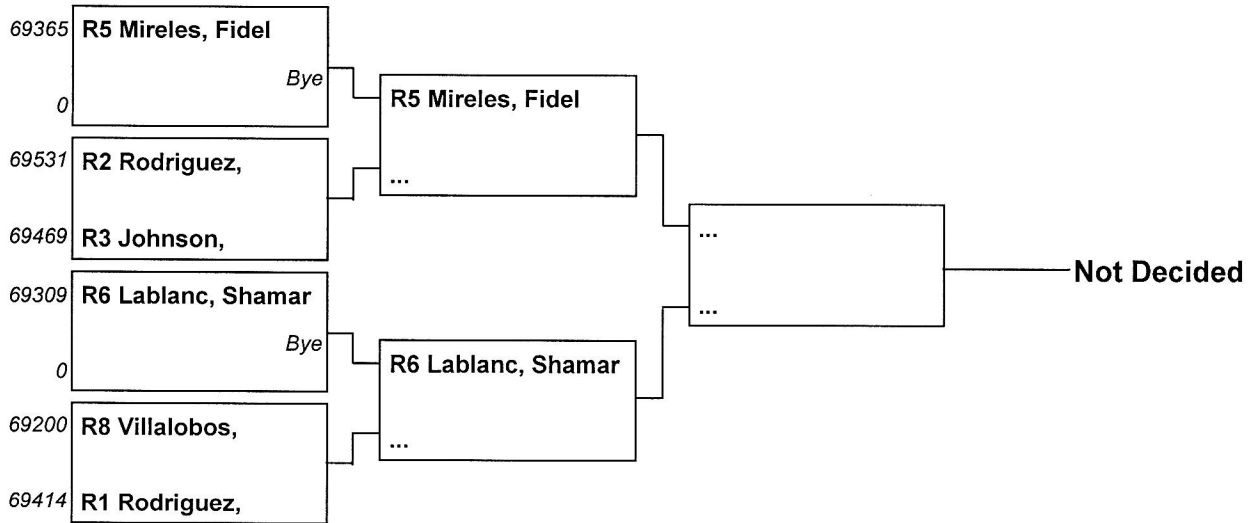

# 2019 National Silver Gloves

Final Bout # 448

## Girls 13 - 14 Open 13 - 14

### 119 Lbs

### !!! CAUTION !!! ==> SUBJECT TO CHANGE !!!

69429	R1 Griffith, Randi	
0		Bye

————— R1 Griffith, Randi

# 2019 National Silver Gloves

Final Bout # 352

## Boys 13 - 14 Open 13 - 14 119 Lbs

**!!! CAUTION !!! ==> SUBJECT TO CHANGE !!!**

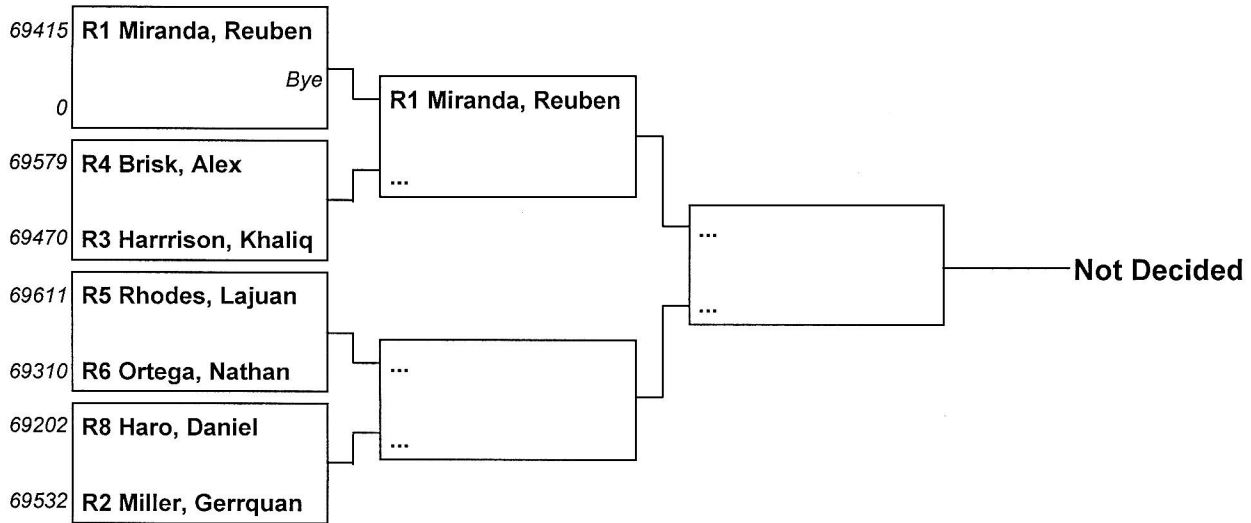

## Girls 13 - 14 Open 13 - 14

### 125 Lbs

### !!! CAUTION !!! ==> SUBJECT TO CHANGE !!!

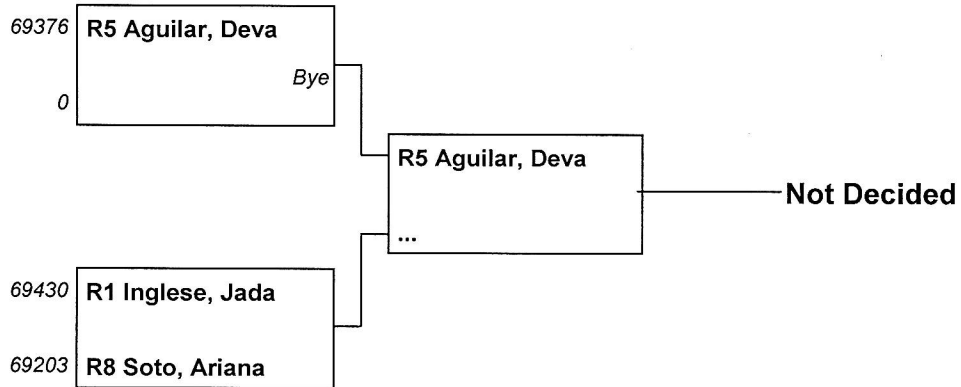

## Boys 13 - 14 Open 13 - 14 125 Lbs

**!!! CAUTION !!! ==> SUBJECT TO CHANGE !!!**

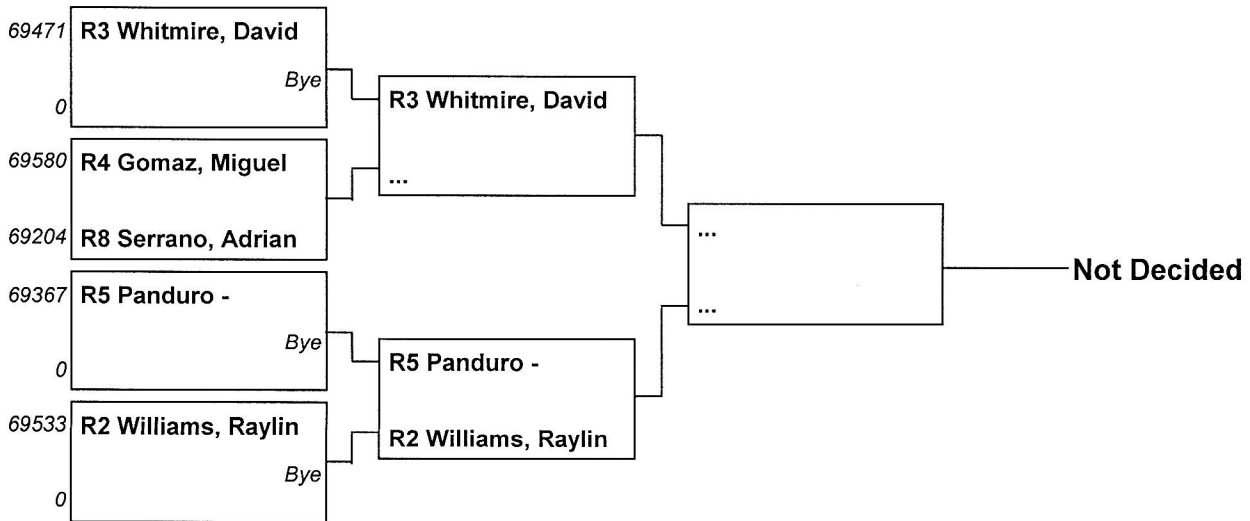

Final Bout # 449

## Girls 13 - 14 Open 13 - 14 132 Lbs

**!!! CAUTION !!! ==> SUBJECT TO CHANGE !!!**

69205	R8 Ocegüera,	—————	Not Decided
69431	R1 Chisholm,		

## Boys 13 - 14 Open 13 - 14

### 132 Lbs

**!!! CAUTION !!! ==> SUBJECT TO CHANGE !!!**

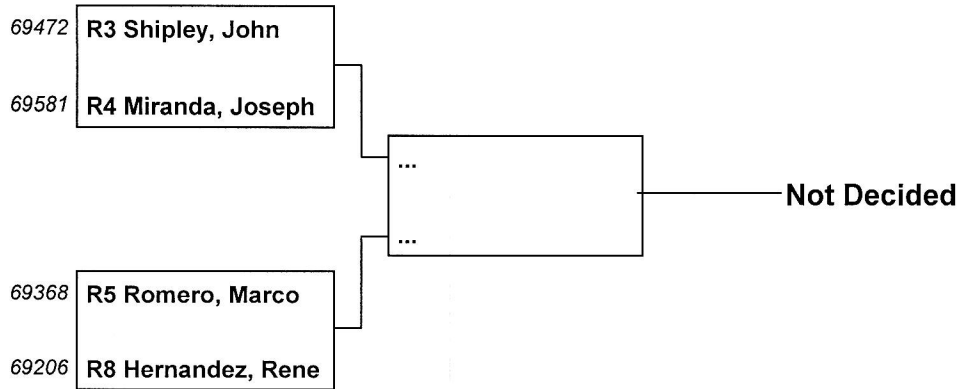

## Girls 13 - 14 Open 13 - 14

### 138 Lbs

**!!! CAUTION !!! ==> SUBJECT TO CHANGE !!!**

69489	<b>R3 King, Mercedes</b>		
0		<i>Bye</i>	<b>R3 King, Mercedes</b>



# 2019 National Silver Gloves

Final Bout # 362

## Boys 13 - 14 Open 13 - 14 138 Lbs

**!!! CAUTION !!! ==> SUBJECT TO CHANGE !!!**

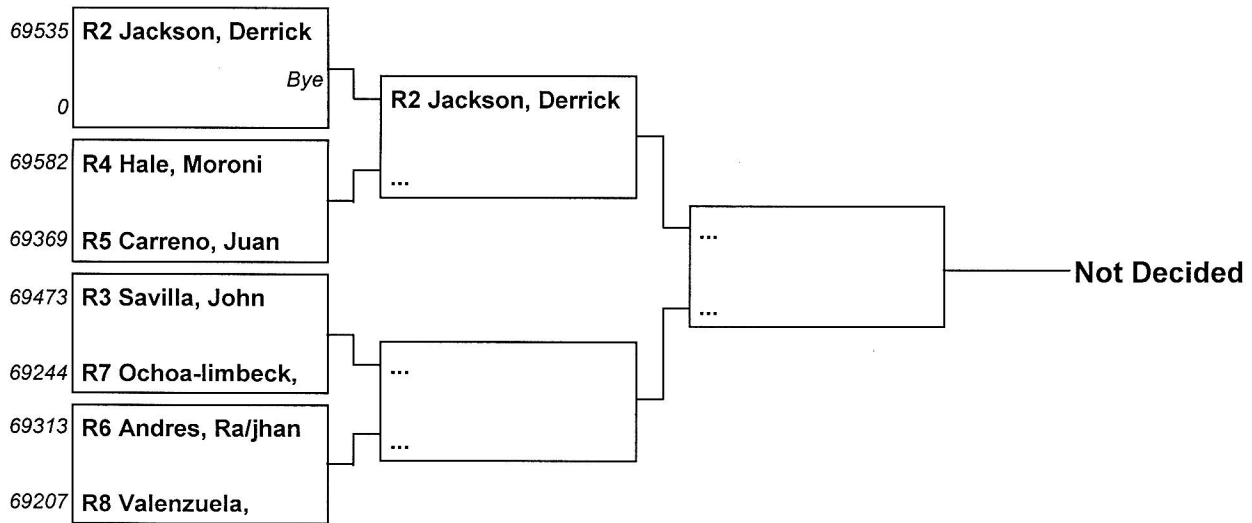

## Girls 13 - 14 Open 13 - 14

### 145 Lbs

**!!! CAUTION !!! ==> SUBJECT TO CHANGE !!!**

69208	<b>R8 Garcia, Genesis</b>	
0		<i>Bye</i>

————— **R8 Garcia, Genesis**

# 2019 National Silver Gloves

Final Bout # 335

## Boys 13 - 14 Open 13 - 14 145 Lbs

**!!! CAUTION !!! ==> SUBJECT TO CHANGE !!!**

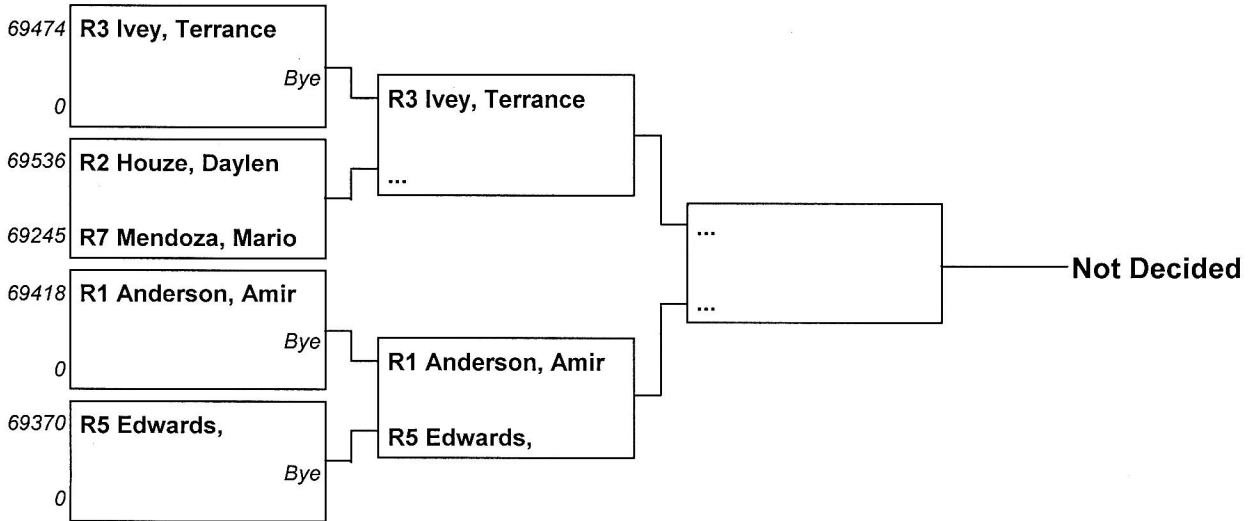

## Boys 13 - 14 Open 13 - 14

### 154 Lbs

**!!! CAUTION !!! ==> SUBJECT TO CHANGE !!!**

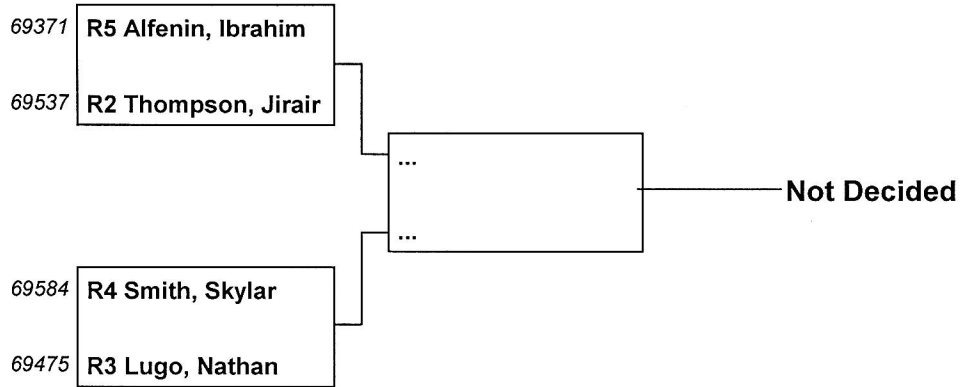

## Girls 13 - 14 Open 13 - 14

### 165 Lbs

**!!! CAUTION !!! ==> SUBJECT TO CHANGE !!!**

69271	<b>R6 Laird, Destiny</b>	————— R6 Laird, Destiny
0	<i>Bye</i>	

## Boys 13 - 14 Open 13 - 14

### 165 Lbs

### !!! CAUTION !!! ==> SUBJECT TO CHANGE !!!

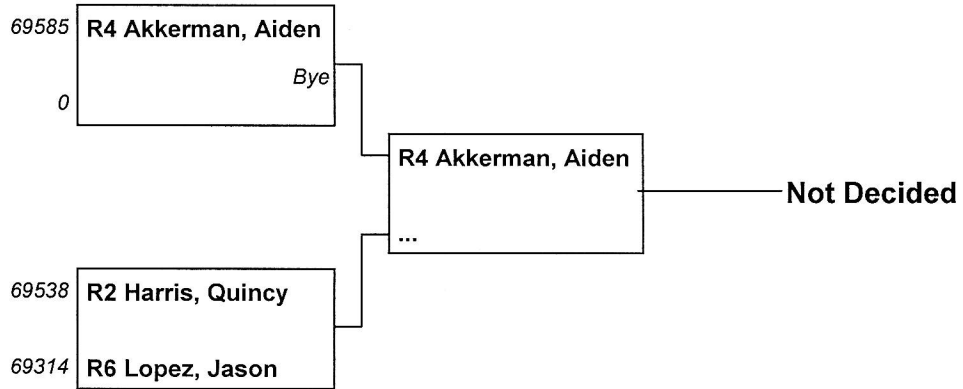

## Boys 13 - 14 Open 13 - 14 176 Lbs

**!!! CAUTION !!! ==> SUBJECT TO CHANGE !!!**

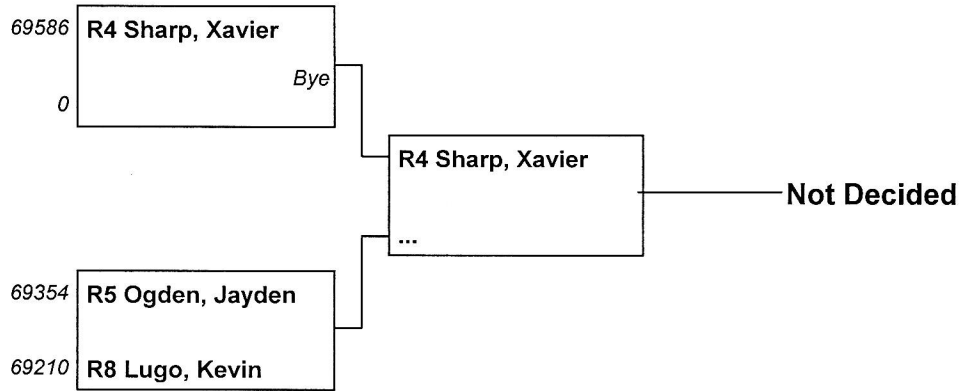

## Girls 13 - 14 Open 13 - 14

### 201 Lbs

**!!! CAUTION !!! ==> SUBJECT TO CHANGE !!!**

69602	<b>R4 Gates, Ma'ste</b>	
0		<i>Bye</i>

————— **R4 Gates, Ma'ste**



## Boys 13 - 14 Open 13 - 14

### 201 Lbs

# !!! CAUTION !!! ==> SUBJECT TO CHANGE !!!

69211	R8 Gonzalez, Juan	
0		Bye

————— R8 Gonzalez, Juan

## Girls 13 - 14 Open 13 - 14

### 201+ Lbs

**!!! CAUTION !!! ==> SUBJECT TO CHANGE !!!**

69490	R3 Anderson, Briana	————— R3 Anderson, Briana
0	Bye	

## Boys 13 - 14 Open 13 - 14

### 201+ Lbs

**!!! CAUTION !!! ==> SUBJECT TO CHANGE !!!**

